



# Public Service Communications Manual

published by  
The American Radio Relay League

## Foreword

Public service communications have been a traditional responsibility of the Amateur Radio Service since 1913, when amateurs at the University of Michigan and Ohio State University, in conjunction with numerous individual amateurs in and around the region, successfully bridged the communications gap surrounding a large isolated area left by a severe windstorm in the Midwest. In those early days, such disaster work was spontaneous and without previous organization of any kind. In today's Amateur Radio, disaster work is a highly organized and worthwhile part of day-to-day operation, implemented principally through the Amateur Radio Emergency Service (ARES) and the National Traffic System (NTS), both sponsored by ARRL. The Radio Amateur Civil Emergency Service (RACES), independent nets and other amateur public service groups are also a part of ARRL-recognized Amateur Radio public service efforts.

The ARES now consists of approximately 80,000 licensed amateurs who have registered their availability for emergency operation in the public interest. The operational leadership of ARES consists of approximately 2500 local and district emergency coordinators, along with the section ECs.

NTS operates daily to handle local, medium and long-distance written traffic in standard ARRL format. NTS consists of nets at four levels, with lines of liaison connecting them for the systematic flow of message traffic from point of origin to point of delivery in the shortest possible time consistent with organizational training objectives and mass handlings.

A subpart of the US amateur regulations (Part 97, Subpart E) provides for the Radio Amateur Civil Emergency Service. RACES is a special phase of amateur operation sponsored by local emergency management agencies with support from the Federal Emergency Management Agency (FEMA), and applies to US amateurs only. The primary purpose of RACES is to provide amateurs with a special opportunity to serve governmental civil preparedness agencies. ARRL has signed a memorandum of understanding with FEMA to enhance the coordination of ARRL and FEMA resources.

This edition of the *Public Service Communications Manual* constitutes an overall source of basic information on the League's public service communications program.

Thanks go to Rob Griffin, AB6YR, Santa Barbara Section Manager and the section's former Section Traffic Manager, and especially Bill Thompson, W2MTA, Western New York Section Manager, for their efforts in making this 1996 edition of the *PSCM* an accurate source of guidance for both the new and experienced public service communicator.

# Table of Contents

	Page
Foreword	1
Introduction	5
<b>Section I: Amateur Radio Emergency Service (ARES)</b>	
<b>Chapter</b>	
<b>One</b>	<b>Amateur Radio Emergency Service</b> <span style="float: right;"><b>7</b></span>
1.1	ARES Organization
1.2	Section Level
1.3	Local Level
1.4	District Level
1.5	Assistant ECs
1.6	Planning Committee
1.7	Operation and Flexibility
1.8	ARES Operation During Emergencies and Disasters
<b>Two</b>	<b>Simulated Emergency Test (SET)</b> <span style="float: right;"><b>12</b></span>
2.1	Purpose of SET
2.2	SET Format
2.3	Preparing for SET
2.4	During the SET
2.5	After the SET
2.6	NTS in SET
2.7	Summary
<b>Three</b>	<b>ARES Mutual Assistance Team (ARESMT) Concept</b> <span style="float: right;"><b>14</b></span>
3.1	Pre-Departure Functions
3.2	In-Travel Functions
3.3	Arrival Functions
3.4	In-situ Functions
3.5	Pre-demobilization and Demobilization Functions
3.6	ARESMT Member Qualifications
3.7	Summary
<b>Four</b>	<b>ARES and RACES</b> <span style="float: right;"><b>17</b></span>
4.1	What is RACES?
4.2	Operating Procedure
4.3	ARES and RACES
4.4	Other Amateur facilities
<b>Five</b>	<b>ARES Principles of Disaster Communications</b> <span style="float: right;"><b>19</b></span>
<b>Six</b>	<b>Working With Public Safety Officials</b> <span style="float: right;"><b>21</b></span>
<b>Seven</b>	<b>On Serving “Served” Agencies</b> <span style="float: right;"><b>23</b></span>

## Section II: National Traffic System (NTS)

Chapter		Page
<b>One</b>	<b>National Traffic System</b>	<b>26</b>
	1.1 Membership in NTS	
	1.2 Mode	
<b>Two</b>	<b>Principles of NTS Operation</b>	<b>28</b>
	2.1 Local Nets	
	2.2 Section Nets	
	2.3 Region Nets	
	2.4 Area Nets	
	2.5 Transcontinental Corps	
	2.6 Digital Stations	
<b>Three</b>	<b>NTS Policies</b>	<b>32</b>
	3.1 Sequence of Net Meetings	
	3.2 Options	
	3.3 Deviation from Normal Routing	
	3.4 Adherence to Schedules	
	3.5 Alternate Routings	
	3.6 Check-in Policy	
	3.7 Boundaries	
	3.8 Nomenclature	
	3.9 Combined Section Nets	
	3.10 Limited Load Capability	
	3.11 Observation of Time	
	3.12 Frequencies	
	3.13 Manager Appointments	
	3.14 Certification	
	3.15 Special Liaison Methods	
<b>Four</b>	<b>Operation During Disasters</b>	<b>38</b>
	4.1 Section Traffic Manager, Net Manager Functions	
	4.2 Region Net Manager Functions	
	4.3 Area Net Manager Functions	
	4.4 Transcontinental Corps Director Functions	
	4.5 Area Staff Chairman Functions	
	4.6 General Policy	
	4.7 Health and Welfare Traffic	

<b>Five</b>	<b>NTS Standard Net Procedures</b>	<b>42</b>
	5.1 Section Nets	
	5.2 Region Nets	
	5.3 Area Nets	
	5.4 Send and Receive Stations	
	5.5 Miscellaneous Procedures	
	5.6 Section and Local NTS Traffic Nodes	
	5.7 HF Digital Stations	
<b>Six</b>	<b>ARRL Precedences and Handling Instructions</b>	<b>45</b>
	6.1 Emergency	
	6.2 Priority	
	6.3 Welfare	
	6.4 Routine	
	6.5 Handling Instructions	
<b>Seven</b>	<b>Operation of the Transcontinental Corps</b>	<b>47</b>
	7.1 TCC Station Functions	
<b>Eight</b>	<b>Operation of the Digital System</b>	<b>51</b>
	8.1 HF Digital NTS Operations	
	8.2 VHF Packet Radio Bulletin Boards	
<b>Nine</b>	<b>NTS Traffic Routing</b>	<b>52</b>
	9.1 Example of NTS Message Routing	
	9.2 NTS Routing Guide	
	9.3 Message Routing in the Digital Station Network	
<b>Ten</b>	<b>Counting Net Traffic</b>	<b>54</b>
	10.1 Net Traffic Count	
	10.2 Individual Traffic Count	
<b>Eleven</b>	<b>On Getting More Traffic</b>	<b>56</b>
<b>Appendix</b>	<b>National Traffic System Terms of Reference</b>	<b>57</b>

# Introduction

Throughout our history, we amateurs have established a reputation for public service communications which is of the greatest importance to our continued occupation of frequencies. At first, this service was rendered spontaneously and on an individual basis. As time progressed, the need for and value of organization became evident, resulting in the establishment of organized trunk lines and net systems; later the Amateur Radio Emergency Service (ARES) and the National Traffic System (NTS) were formed to complete the organization. The ARRL Field Organization includes the combined facilities of the Amateur Radio Emergency Service, as it has developed since 1935, and the National Traffic System, which was begun in 1949.

It is significant that Part 97 of the FCC's Rules and Regulations states, as the first principle under "Basis and Purpose," the following:

*"Recognition and enhancement of the value of the amateur service to the public as a voluntary non-commercial communication service, particularly with respect to providing emergency communications."*

ARES and NTS exist as the League's implementation of this basic principle. ARES and NTS have much in common. Every emergency net is bound to be, to some extent, a traffic net, and every traffic net should be prepared to take on various forms of emergency-related communications duties. Emergency-conscious and traffic-conscious operators have this in common: They both derive their chief reward out of activities, which are directly beneficial not only to Amateur Radio, but also to their communities and country.

## Implementation: The ARRL Field Organization

### **Basic Organization and Functions**

The organization chart in Figure 1 (page 6) shows how ARES and NTS work together from top to bottom. Most ARES nets exist only at the local level, and are tied into NTS at local or section level for integration into the national system. The overall support for all levels of ARES and NTS is provided by the Field Services Department at ARRL Headquarters.

Leadership in the emergency division (ARES) is exercised by the Section Emergency Coordinator and the District ECs and local ECs, as shown; in the traffic division (NTS) by Section Traffic Manager and by Net/Node Managers at the local and section levels.

Usually, emergency operation is initiated at the local level and is the business of the ARES local Emergency Coordinator. Even if the emergency situation transcends the local level and becomes of statewide, regional, or even national concern, the immediate situation and what to do about it are primarily the concern of local ARES officials. Much of the emergency messages and other communications will be generated by civic and welfare officials, or at their request, with resulting logistical challenges in effecting their conveyance, and are handed to the ARES for solution.

While ARES and NTS are two of the ARRL's public service organizations, it should not be concluded that this is all that there is to Amateur Radio public service, or that this is the extent of the League's interest in public service communications. On the contrary, there are many other amateur public service operating groups under different sponsorship which are a vital part of the public service function of the Amateur Radio Service. As such, they merit and receive the League's recognition and assistance to the extent desired and feasible.

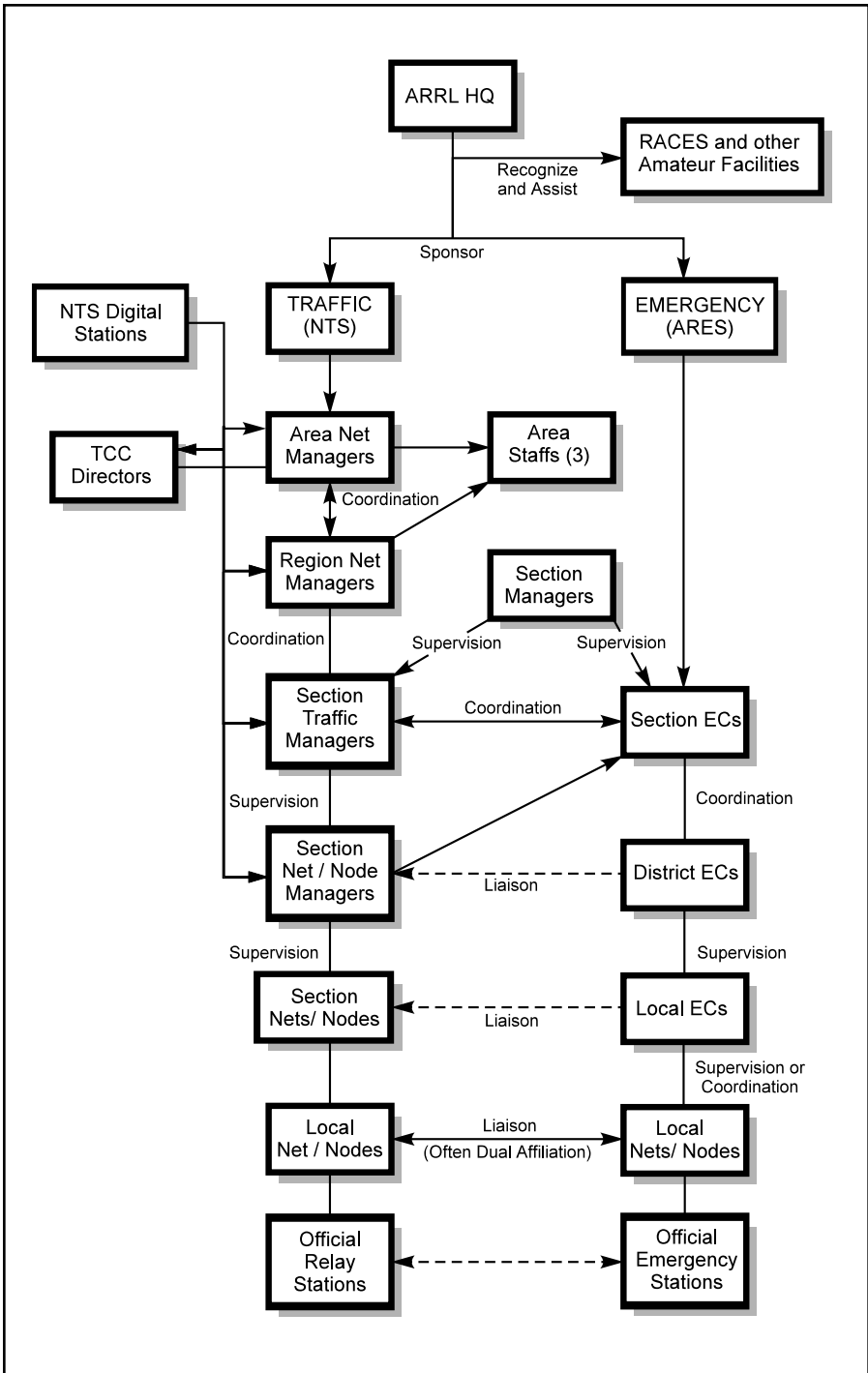
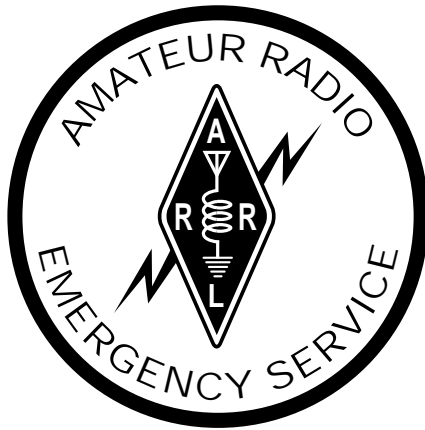

Fig 1—ARRL ARES/NTS diagram

**Section I:**  
**The Amateur Radio Emergency Service**  
**(ARES)**



# ARES Chapter One

## Amateur Radio Emergency Service (ARES)

The Amateur Radio Emergency Service (ARES) consists of licensed amateurs who have voluntarily registered their qualifications and equipment for communications duty in the public service when disaster strikes. Every licensed amateur, regardless of membership in ARRL or any other local or national organization, is eligible for membership in the ARES. The only qualification, other than possession of an Amateur Radio license, is a sincere desire to serve. Because ARES is an amateur service, only amateurs are eligible for membership. The possession of emergency-powered equipment is desirable, but is not a requirement for membership.

### 1.1 ARES Organization

There are four levels of ARES organization—national, section, district and local. National emergency coordination at ARRL Headquarters is under the supervision of the ARRL Field Services Manager, who is responsible for advising all ARES officials regarding their problems, maintaining contact with federal government and other national officials concerned with amateur emergency communications potential, and in general with carrying out the League's policies regarding emergency communications.

### 1.2 Section Level

At the section level, the Section Emergency Coordinator is appointed by the Section Manager (who is elected by the ARRL members in his or her section) and works under his/her supervision. In most sections, the SM delegates to the SEC the administration of the section emergency plan and the authority to appoint District and local ECs. Some of the ARRL sections with capable SECs are well-organized. A few have scarcely any organization at all. It depends almost entirely on who the section members have put into office as SM and whom he/she has appointed as SEC.

### 1.3 Local Level

It is at the local level where most of the real emergency organizing gets accomplished, because this is the level at which most emergencies occur and the level at which ARES leaders make direct contact with the ARES member-volunteers and with officials of the agencies to be served. The local EC is therefore the key contact in the ARES. The EC is appointed by the SEC, usually on the recommendation of the DEC. Depending on how the SEC has set up the section for administrative purposes, the EC may have jurisdiction over a small community or a large city, an entire county or even a group of counties. Whatever jurisdiction is assigned, the

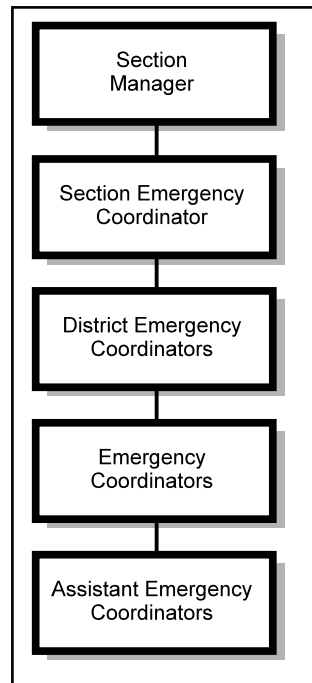

Fig 2—Section structure for ARES.



EC is in charge of all ARES activities in his area, not just one interest group, one agency, one club or one band.

#### *1.4 District Level*

In the large sections, the local groups could proliferate to the point where simply keeping track of them would be more than a full-time chore, not to mention the idea of trying to coordinate them in an actual emergency. To this end, SECs have the option of grouping their EC jurisdictions into logical units or “districts” and appointing a District EC to coordinate the activities of the local ECs in the district. In some cases, the districts may conform to the boundaries of governmental planning or emergency-operations districts, while in others they are simply based on repeater coverage or geographical boundaries. Fig 2 depicts the typical section ARES structure.

#### *1.5 Assistant ECs*

Special-interest groups are headed up by Assistant Emergency Coordinators, designated by the EC to supervise activities of groups operating in certain bands, especially those groups that play an important role at the local level, but they may be designated in any manner the EC deems appropriate.

#### *1.6 Planning Committee*

These assistants, with the EC as chairman, constitute the local ARES planning committee and they meet together from time to time to discuss problems and plan projects to keep the ARES group active and well-trained.

There are any number of different situations and circumstances that might confront an EC, and his/her ARES unit should be organized in anticipation of them. An EC for a small town might find that the licensed amateur group is so small that appointing assistants is unnecessary or undesirable. On the other hand, an EC for a large city may find that even his assistants need assistants and that sometimes it is necessary to set up a special sub-organization to handle it. There is no specific point at which organization ceases and operation commences. Both phases must be concurrent because a living organization is a changing one, and the operations of a changing organization must change with the organization.

#### *1.7 Operation and Flexibility*

We have discussed how a typical ARES unit may be organized. Just what shape the plan in your locality will take depends on what your EC has to work with. He uses what he has, and leaves provision in the plan for what he/she hopes, wants and is trying to get. Flexibility is the keynote. The personnel, equipment and facilities available today may not be available tomorrow; conversely, what is lacking today may be available tomorrow. In any case, bear in mind that organizing and planning are not a one-person task. The EC is simply the leader, or, as the title indicates, the coordinator. His effectiveness inevitably will depend on what kind of a group he has to work with; that is, on you and your cohorts. Make yourself available to your EC as a member of his planning committee, or in any capacity for which you think you are qualified.

Local ARES operation will usually take the form of nets—HF nets, VHF (repeater) nets, even RTTY, packet or other special-mode nets, depending on need and resources available. Your EC should know where your particular interests lie, so that you can be worked in where your special talents will do the most good.

It is not always possible to use the services of all ARES members. While it is general policy that no ARES member must belong to any particular club or

organization to participate in the program, local practical considerations may be such that you cannot be used. This is a matter that has to be decided by your EC. In some cases, even personality conflicts can cause difficulties; for example, the EC may decide that he cannot work with a particular person, and that the local ARES would be better served by excluding that person. This is a judgment that the EC would have to make; while personality conflicts should be avoided, they do arise, more often than we would prefer. The EC on the job must take the responsibility for making such subjective evaluations, just as the SEC and DEC must evaluate the effectiveness of the job being done by the EC.

### *1.8 ARES Operation During Emergencies and Disasters*

Operation in an emergency net is little different from operation in any other net, and requires preparation and training. This includes training in handling of written messages—that is, what is generally known as “traffic handling.” Handling traffic is covered in detail in the ARRL *Operating Manual*. This is required reading for all ARES members—in fact, for all amateurs aspiring to participate in disaster communications.

The specifications of an effective communication service depend on the nature of the information which must be communicated. Pre-disaster plans and arrangements for disaster communications include:

- Identification of clients who will need Amateur Radio communication services.
- Discussion with these clients to learn the nature of the information they will need to communicate, and the people they will need to communicate with.
- Specification, development and testing of pertinent services.

While much amateur-to-amateur communicating in an emergency is of a procedural or tactical nature, the real meat of communicating is formal written traffic for the record. Formal written traffic is important for:

- A record of what has happened—frequent status review, critique and evaluation. Completeness, which minimizes omission of vital information.
- Conciseness, which when used correctly actually takes less time than passing informal traffic.
- Easier copy—receiving operators know the sequence of the information, resulting in fewer errors and repeats.

When relays are likely to be involved, standard ARRL message format should be used. The record should show, wherever possible:

1. A message number for reference purposes.
2. A precedence indicating the importance of the message.
3. A station of origin so any reply or handling inquiries can be referred to that station.
4. A check (count of the number of words in the message text) so receiving stations will know whether any words were missed.
5. A place of origin, so the recipient will know where the message came from (not necessarily the location of the station of origin).
6. Filing time, ordinarily optional but of great importance in an emergency message.
7. Date of origin.

The address should be complete and include a telephone number if known. The text should be short and to the point, and the signature should contain not only the name of the person sending the message but his title or connection

also, if any.

Point-to-point services for direct delivery of emergency and priority traffic do not involve relays. Indeed, the full ARRL format is often not needed to record written traffic. Shortened forms should be used to save time and effort. For example, the call sign of the originating station usually identifies the place of origin. Also, the addressee is usually known and close by at the receiving station, so full address and telephone number are often superfluous. In many cases, message blanks can be designed so that only key words, letters or numbers have to be filled in and communicated. In some cases, the message form also serves as a log of the operation. Not a net goes by that you don't hear an ARL Fifty or an ARL Sixty One. Unfortunately, "greetings by Amateur Radio" does not apply well during disaster situations. You may hear an ARL text being used for health and welfare traffic, but rarely during or after the actual disaster. Currently, no ARL text describes the wind speed and barometric pressure of a hurricane, medical terminology in a mass casualty incident or potassium iodide in a nuclear power plant drill. While no one is suggesting that an ARL text be developed for each and every situation, there is no reason why amateurs can't work with the local emergency management organizations and assist them with more efficient communications.

Amateurs are often trained and skilled communicators. The emergency management community recognizes these two key words when talking about the Amateur Radio Service. Amateurs must use their skills to help the agencies provide the information that needs to be passed, while at the same time showing their talents as trained communicators who know how to pass information quickly and efficiently. We are expected to pass the information accurately, even if we do not understand the terminology.

Traffic handlers and ARES members are resourceful individuals. Some have developed other forms or charts for passing information. Some hams involved with the SKYWARN program, for instance, go down a list and fill in the blanks, while others use grid squares to define a region. Regardless of the agency that we are working with, we must use our traffic-handling skills to the utmost advantage. Sure, ARL messages are beneficial when we are passing health and welfare traffic. But are they ready to be implemented in times of need in your community? The traffic handler, working through the local ARES organizations, must develop a working relationship with those organizations who handle health and welfare inquiries. Prior planning and personal contact are the keys to allowing an existing National Traffic System to be put to its best use. If we don't interface with the agencies we serve, the resources of the Amateur Radio Service will go untapped.

Regardless of the format used, the appropriate procedures cannot be picked up solely by reading or studying. There is no substitute for actual practice. Your emergency net should practice regularly—much more often than it operates in a real or simulated emergency. Avoid complacency, the feeling that you will know how to operate when the time comes. You won't, unless you do it frequently, with other operators whose style of operating you get to know.

# ARES Chapter Two

## Simulated Emergency Test (SET)

The ARRL Simulated Emergency Test is a nationwide exercise in emergency communications, administered by ARRL Emergency Coordinators and Net Managers. Both ARES and the National Traffic System (NTS) are involved. The SET weekend gives communicators the opportunity to focus on the emergency communications capability within their community while interacting with NTS nets. SET weekend is held in October, and is announced in *QST*.

### 2.1 Purpose of SET

1. To find out the strengths and weaknesses of ARES and NTS, the Radio Amateur Civil Emergency Service (RACES) and other groups in providing emergency communications.

2. To provide a public demonstration—to served agencies such as Red Cross, Civil Preparedness, and through the news media—of the value to the public that Amateur Radio provides, particularly in time of need.

3. To help radio amateurs gain experience in communications using standard procedures and a variety of modes under simulated emergency conditions.

### 2.2 SET Format

The scoring format reflects broad objectives and encourages recruitment of new hams and use of digital modes for handling high-volume traffic and point-to-point Welfare reports out of the affected simulated-disaster area. Participants will find SET an opportunity to strengthen the VHF-HF link at the local level, thereby ensuring that ARES and NTS are working in concert. The SET will give all levels of NTS the chance to handle exercise-related traffic. The guidelines also recognize tactical traffic on behalf of served agencies.

ARES units and other groups are free to conduct their SETs anytime between September 1 and November 30 if an alternative date is preferred. The activity period should not exceed 48 hours. The deadline for receipt of all reports is January 31. A complete array of reporting forms will be mailed to affected Field Organization appointees.

### 2.3 Preparing for SET

*Emergency Coordinators* sign up all available amateurs in their area and work them into the SET plans. They make special efforts to attract new Technicians as outlined earlier.

A meeting of all ARES members and prospective members is called to briefly outline (no details!) SET activities, and give general instructions. ECs contact served agencies and explain the intent and overall purpose of the SET, offer to send test messages to other branches of their agencies, and invite officials to ARES meetings and SET operating sites. Publicity is arranged in consultation with an ARRL Public Information Officer in local newspapers and radio/TV stations.

### 2.4 During the SET

The “emergency” situation is announced and the emergency net is activated. Stations are dispatched to served agencies. Designated stations originate messages on behalf of served agencies. Test messages may be sent simulating requests for supplies. Simulated emergency messages (just like real emergency

messages) should be signed by an authorized official. Tactical communications for served agencies is emphasized.

At least one session (or substantial segment of a session) of the local net should be conducted on emergency-only basis. Or, if a repeater is on emergency power, only emergency-powered stations should be allowed to operate through the repeater for a certain time period.

### *2.5 After the SET*

An important post-SET activity is a critique session to discuss the test results. All ARES (and RACES) members should be invited to the meeting to review good points and weaknesses apparent in the drill.

### *2.6 NTS in SET*

The main function of NTS in an emergency situation is to tie together all of the various local activities and to provide a means by which all traffic destined outside of a local area, section or region can be systematically relayed to the addressee.

The interface between NTS and ARES lies in the liaison function between local nets and other NTS nets, particularly at the section level. Responsibility for representation of the local network on the section net lies with the local net manager who may or may not be the EC.

At least one net session or substantial segment of a session should be conducted on emergency power. A surprise session or two should be conducted.

### *2.7 Summary*

One of the first steps on the way to a successful SET is to try to get as many people involved as possible, and especially new hams. In a real emergency, we find amateurs with all sorts of varied interests coming out of the woodwork. Get them involved in SET so they will know more about how emergency communications should be handled. Promote SET on nets and repeaters, and sign up new, enthusiastic Technicians.

# ARES Chapter Three

## ARES Mutual Assistance Team (ARESMAT) Concept

The ARESMAT concept recognizes that a neighboring section's ARES resources can be quickly overwhelmed in a large-scale disaster. ARES members in the affected areas may be preoccupied with mitigation of their own personal situations and therefore not able to respond in local ARES operations. Accordingly, communications support must come from ARES personnel outside the affected areas. This is when help may be requested from neighboring sections' ARESMAT teams. To effect inter-sectional support mechanisms, each Section Emergency Coordinator (SEC) should consider adopting the following principles in their ARES planning:

- Pre-disaster planning with other sections in the Division, and adjoining sections outside the Division. Planning should be conducted through written memoranda and in-person at conventions and director-called cabinet meetings. An ARESMAT inter-sectional emergency response plan should be drafted.
- Development of a roster of ARESMAT members able, willing and trained to travel to neighboring sections to provide communication support inside the disaster area.
- Inter-sectional communication/coordination during and immediately following the onslaught of the disaster.
- Post-event evaluation and subsequent revision/updating of the inter-sectional emergency response plan.

When developing ARESMAT functions, ARES leadership should include the following basic action elements:

### *3.1 Pre-Departure Functions*

Team leaders should provide ARESMAT members with notification of activation/assignment. Credentials should be provided for recognition by local authorities. They should provide a general and technical briefing on information drawn principally from the requesting authority, supplemented by reports from Amateur Radio, commercial radio, W1AW bulletins, and ARRL officials. The briefing should include an overview of equipment and communication needs, ARESMAT leadership contacts, and conditions in the disaster area.

The host SEC's invitation, transportation (including routes in disaster area) and accommodations considerations, and expected length of deployment should all also be reviewed with the team members.

### *3.2 In-Travel Functions*

Before and while in travel to the affected areas, team leaders should review the situation's status with the team: job assignments, checklists, affected area profile, mission disaster relief plan, strengths and weaknesses of previous and current responses, maps, technical documents, contact lists, tactical operation procedures, and response team requirements.

### *3.3 Arrival Functions*

Upon arrival, team leaders should check with host ARES officials and obtain information about frequencies in use, current actions, available personnel, communication and computer equipment, and support facilities that could be used by the team to support the relief effort. The host's ARES plan in effect for

the disaster should be obtained. A priority upon arrival should be the establishment of an initial intra-team communication network and an HF or VHF channel back to the home section for morale traffic.

Team leaders should meet with served agencies, Amateur Radio clubs' communications staff, local ARRL communications authority, and others as needed to obtain information and coordinate the use of frequencies. Communication site selections should take into account team requirements and local constraints.

### *3.4 In-situ Functions*

Team leaders should make an initial assessment of functioning communication facilities, and monitor host ARES officials' communications, and other response team relief efforts to coordinate operations and reduce duplication of effort. Team members should be monitored and their capabilities to perform their duties evaluated. Proper safety practices and procedures must be followed. A daily critique of communication effectiveness with served units and communication personnel should be conducted.

### *3.5 Pre-Demobilization and Demobilization Functions*

An extraction procedure for ham communicators should be negotiated with served agencies and host ARES officials before it is needed. To get volunteers' commitment to travel and participate, they must be assured that there will be an end to their commitment. Open-ended commitments of volunteers are undesirable, partly because they make potential volunteers hesitate to become involved.

Leaders must coordinate with the host ARES officials and served agencies, and other functions to determine when equipment and personnel are no longer needed. A demobilization plan should be in effect.

A team critique, begun on the trip home, should be conducted, and individual performance evaluations on team members should be prepared. Copies of critiques should be sent to both the home SEC and in-disaster SEC. Problems stemming from personality conflicts should be addressed and/or resolved outside of formal reports, as they only provide distractions to the reports. Equipment should be accounted for.

A post-event evaluation meeting should always be conducted, and a final report prepared upon which an update to the inter-sectional ARESMAT plan can be made.

### *3.6 ARESMAT Member Qualifications*

The individual filling the role of ARESMAT member must have high performance standards, qualifications, experience, and the ability to work with a diverse group of team members that will be required to provide relief to the affected areas. He or she must be able to work efficiently in a disaster relief operation under the most adverse conditions.

Additionally, a member should have demonstrated ability to be an effective team player in crisis situations, a strong personal desire, and strong interpersonal communication skills. A knowledge of how ARRL, Red Cross and other agencies function at both the national and local levels is helpful. A working knowledge of the incident command system is useful as many events are managed under this system.

Members should be respected and recognized by officials and peers as competent communicators, and should understand a broad range of disaster response organizations' capabilities and communication requirements.

Obvious, perhaps, but important: Members must be available with the

consent of their employer to participate!

They should be physically fit to perform arduous work under adverse environmental conditions.

### *3.7 Summary*

It should be noted that there is a fine balance of authority over a deployed ARESMAT. The in-disaster SEC (or delegated authority) should be able to make decisions as to use and deployment of an incoming team. Therefore, an incoming team should be prepared to submit themselves to such authority; this is evidenced by the fact that any team, internal or external, has only a limited view of the overall operation. The supervising authorities will naturally have a better overview of the whole situation.

In turn, however, the in-disaster authority should be discouraged from abusing the resources of incoming teams. Should a team no longer be required, or a situation de-escalate, the team should be released at the earliest possible time, so that they may return home to their own lives.

The ARESMAT tool should be one of “last resort—better than nothing.” Whenever possible, amateurs from the affected section should be used for support. It is a lot to ask of a volunteer to travel far from home, family and job for extended periods of arduous and potentially dangerous work.



# ARES Chapter Four

## ARES and RACES

After World War II, when it became evident that the international situation was destined to be tense and the need for some civil-defense measures became apparent, successive government agencies designated to head up such a program called on amateur representatives to participate. In the discussions that followed, amateurs were interested in getting two points across: First, that Amateur Radio had a potential for and capability of playing a major role in this program; and second, that our participation should, this time as never before, be in our own name, as an Amateur Radio Service, even if and after war should break out. These principles were included into the planning by the formulation of regulations creating a new branch of the amateur service, the Radio Amateur Civil Emergency Service, RACES.

Recognition of the role of Amateur Radio as a public service means responsibility—this time in our own name. The RACES regulations are printed in full in the ARRL publication *The FCC Rule Book*, along with the rest of the amateur regulations, and are not reprinted here. Every amateur should study closely and become familiar with these rules; civil preparedness, now a major function, may become our only on-the-air function if we are plunged into war.

### 4.1 What is RACES?

RACES, administered by local, county and state emergency management agencies, and supported by the Federal Emergency Management Agency (FEMA) of the United States government, is a part of the Amateur Radio Service that provides radio communications for civil-preparedness purposes *only*, during periods of local, regional or national civil emergencies. These emergencies are not limited to war-related activities, but can include natural disasters such as fires, floods and earthquakes.

As defined in the rules, RACES is a radiocommunication service, conducted by volunteer licensed amateurs, designed to provide emergency communications to local or state civil-preparedness agencies. It is important to note that RACES operation is authorized by emergency management officials only, and this operation is strictly limited to official civil-preparedness activity in the event of an emergency-communications situation.

### 4.2 Operating Procedure

Amateurs operating in a local RACES organization must be officially enrolled in the local civil-preparedness agency having jurisdiction. RACES operation is conducted by amateurs using their own primary station licenses, and by existing RACES stations. The FCC no longer issues new RACES (WC prefix) station call signs. Operator privileges in RACES are dependent upon, and identical to, those for the class of license held in the Amateur Radio Service. All of the authorized frequencies and emissions allocated to the Amateur Radio Service are also available to RACES on a shared basis. But in the event that the President invokes his War Emergency Powers, amateurs involved with RACES might be limited to certain specific frequencies (while all other amateur operation could be silenced). See Table 1 (page 18).

While RACES was originally based on potential use for wartime, it has evolved over the years, as has the meaning of civil defense (which is also called civil

**Table 1****Dedicated RACES Operating Frequencies**

1800-1825 kHz	21.228-21.267 MHz
1975-2000 kHz	28.55-28.75 MHz
3.50-3.55 MHz	29.237-29.273 MHz
3.93-3.98 MHz	29.45-29.65 MHz
3.984-4.000 MHz	50.35-50.75 MHz
7.079-7.125 MHz	52-54 MHz
7.245-7.255 MHz	144.50-145.71 MHz
10.10-10.15 MHz	146-148 MHz
14.047-14.053 MHz	222-225 MHz
14.22-14.23 MHz	420-450 MHz
14.331-14.350 MHz	1240-1300 MHz
21.047-21.053 MHz	2390-2450 MHz

preparedness), to encompass all types of emergencies. While operating in a RACES capacity, RACES stations and amateurs registered in the local RACES organization may not communicate with amateurs not operating in a RACES capacity. (Of course, such restrictions do not apply when such stations are operating in a non-RACES—such as ARES—amateur capacity.) Only civil-preparedness communications can be transmitted. Test and drills are permitted only for a maximum of one hour per week. All test and drill messages must be clearly so identified.

#### 4.3 ARES and RACES

Although RACES and ARES are separate entities, the ARRL advocates dual membership and cooperative efforts between both groups whenever possible for an ARES group whose members are all enrolled in and certified by RACES to operate in an emergency with great flexibility. Using the same operators and the same frequencies, an ARES group also enrolled as RACES can “switch hats” from ARES to RACES and RACES to ARES to meet the requirements of the situation as it develops. For example, during a “nondeclared emergency,” ARES can operate under ARES, but when an emergency or disaster is officially declared by a state or federal authority, the operation can become RACES with no change in personnel or frequencies.

This situation is still not well understood and accepted throughout the United States; both ARES and RACES still exist, separately, in many areas. League officials will have to determine the situation in their own area. Where there is currently no RACES, it would be a simple matter for an ARES group to enroll in that capacity, after a presentation to the civil-preparedness authorities. In cases where both ARES and RACES exist, it is possible to join both or to be involved in either. As time progresses, the goal would be the merger into one strong organization, with coordination between ARES and RACES officials using the same groups of amateurs. In some sections of the US today, the ARES structure has also been accepted as the RACES structure.

#### 4.4 Other Amateur Facilities

There are a number of other Amateur Radio facilities, not sponsored or directly affiliated with the League, which are nevertheless an integral part of our public service effort. Some of these organizations are the monitoring services, MARS, independent nets (both international and domestic) and other similar activities. While naturally we want you to participate in organizations sponsored by your League, it's better to participate in a non-League sponsored public service organization than not to participate at all. In this booklet we cannot give details of the operation of these other organizations because there are too many of them, and their operations change too rapidly. Suffice it to say that they do exist, and they are worthy of your support.

# ARES Chapter Five

## ARES Principles of Disaster Communication

It is impossible to state exact rules that will cover every situation that arises. The good amateur faced with a disaster situation may, however, benefit greatly from certain rules of thumb. These rules are, or should be, part of his/her training in his/her ARES group. They are presented here somewhat at random and should be reviewed by all amateurs, even those not active in disaster communications preparation.

**1. Keep the QRM level down.** In a disaster, many of the most crucial stations will be weak in signal strength. It is most essential that all other stations remain silent unless they are called upon. If you're not sure you should transmit, don't. Our amateur bands are very congested. If you want to help, study the situation by listening. Don't transmit unless you are sure you can help by doing so. Don't ever break into a disaster net just to inform the control station you are there if needed.

**2. Monitor established disaster frequencies.** Many localities and some geographical areas have established disaster frequencies where someone is always (or nearly always) monitoring for possible calls. When you are not otherwise engaged, it is helpful simply to sit and listen on such frequencies, some of which are used for general ragchewing as well as disaster preparedness drilling. On CW, SOS is universally recognized, but has some legal aspects that should be considered where the need is not truly crucial. On voice, one can use "MAYDAY" (universal, the phone equivalent of SOS) or, to break into a net or conversation, the word "emergency."

**3. Avoid spreading rumors.** During and after a disaster situation, especially on the phone bands, you may hear almost anything. Unfortunately, much misinformation is transmitted. Rumors are started by expansion, deletion, amplification or modification of words, exaggeration or interpretation. All addressed transmissions should be officially authenticated as to their source. These transmissions should be repeated word for word, if at all, and only when specifically authorized. In a disaster emergency situation, with everyone's nerves on edge, it is little short of criminal to make a statement on the air without foundation in authenticated fact.

**4. Authenticate all messages.** Every message which purports to be of an official nature should be written and signed. Whenever possible, amateurs should avoid initiating disaster or emergency traffic themselves. We do the communicating; the agency officials we serve supply the content of the communications.

**5. Strive for efficiency.** Whatever happens in an emergency, you will find hysteria and some amateurs who are activated by the thought that they must be "sleepless heroes." Instead of operating your own station full time at the expense of your health and efficiency, it is much better to serve a shift at one of the best-located and best-equipped stations, suitable for the work at hand, manned by relief shifts of the best-qualified operators. This reduces interference and secures well-operated stations.

**6. Select the mode and band to suit the need.** It is a characteristic of all amateurs to believe that their favorite mode and band is superior to all others. For certain specific purposes and distances, this may be true. However, the merits of a particular band or mode in a communications emergency should be evaluated impartially with a view to the appropriate use of bands and modes.

There is, of course, no alternative to using what happens to be available, but there are ways to optimize available communications. Long experience has developed the following advantages:

### **CW Mode**

- Less QRM in most amateur bands.
- Secrecy of communications—contents of communications are much less likely to be intercepted by the general public to start rumors or undue concern.
- Simpler transmitting equipment.
- Greater accuracy in record communications.
- Longer range for a given amount of power.

### **Voice Mode**

- More practical for portable and mobile work.
- More widespread availability of operators.
- Faster communication for tactical or “command” purposes.
- More readily appreciated and understood by the public.
- Official-to-official and phone-patch communication.

### **Digital Modes**

Greater speed in record communication than some of the other modes, and—in most of these modes—error detection. In addition, digital modes offer the potential for message store-and-forward capability from within the disaster site to the “outside world.” Finally, packet provides the capability of “digipeating” messages from point A to point Z via numerous automatically controlled middle points.

The well-balanced disaster organization will have CW, phone, and digital mode capabilities available in order to utilize all of the advantages. Of course, one must make the best use of whatever is available, but a great deal of efficiency is lost when there is lack of coordination between the different types of operation in an emergency. Absolute impartiality and a willingness to let performance speak for itself are prime requisites if we are to realize the best possible results.

**7. Use all communications channels intelligently.** While the prime object of emergency communications is to save lives and property (anything else is incidental), Amateur Radio is a secondary communications means; normal channels are primary and should be used if available. Emergency channels other than amateur which are available in the absence of amateur channels should be utilized without fear of favoritism in the interest of getting the message through.

**8. Don't “broadcast.”** Some amateur stations in an emergency situation have a tendency to emulate “broadcast” techniques. While it is true that the general public may be listening, our transmissions are not and should not be made for that purpose. Broadcast stations are well equipped to perform any such service. Our job is to communicate *for*, not *with* the general public.

**9.** Within the disaster area itself, the ARES is primarily responsible for communications support. When disaster strikes, the first priority of those NTS operators who live in or near the disaster area is to make their expertise available to their Emergency Coordinator where and when needed. For timely and effective response, this means that NTS operators need to talk to their ECs before the time of need so that they will know how to best respond.

# ARES Chapter Six

## Working with Public Safety Officials

Public service communications performed by ARES members are based on a number of requirements. Specifically, we must be accepted by public-safety officials; once accepted, our continued ability to contribute in times of disaster is based on the efficiency and effectiveness of our performance. While acceptance, image, efficiency and effectiveness are all important to the ongoing working relationships between amateurs and officials, it is the initial acceptance that is often difficult to achieve.

Police and fire officials tend to be very cautious and skeptical concerning those who are not members of the public-safety professions. This posture is based primarily on experiences in which well-intended but somewhat overzealous volunteers have complicated, and in some cases jeopardized, efforts in emergencies. The amateur operator or other volunteer who wishes to be of assistance must be aware of this perception.

The police have generally had their fill of “groupies” or “hangers on.” They can ill afford to tolerate frustrated individuals who have always wanted to be police officers or firefighters, but for one reason or another have never reached that objective. There seems to be an abundance of people, especially during a crisis, who will quickly overstep the limits of their authority and responsibility if they are given any opportunity to assist in an official capacity. In their zeal, such persons often inhibit the actions of trained personnel. Worse yet, they can make an already dangerous situation even more so by their reckless abandon. With rare exception, Amateur Radio operators do not fall into this category. The problem is, however, that police officers in the midst of stressful operations may have extreme difficulty in distinguishing between those volunteers who are problem solvers and those who are problem makers.

Those very few hams who behave emotionally, are overzealous in offering their services or in describing their abilities or who abuse the established limits of their authority are doing the amateur fraternity a real disservice. The typical police officer or firefighter, like the typical civilian, does not understand the vast differences among various radio services, the types of licensing involved or the high level of expertise and discipline that is characteristic of the Amateur Radio Service.

When an amateur arrives at a scene and jumps out of a vehicle with a hand-held in each fist and two more clipped to the belt, all squawking at once, officials simply don't know how to respond. They are either overwhelmed by equipment they don't understand, or so awe-struck that they try to avoid what they perceive as threatening.

How Amateur Radio volunteers are accepted depends on their establishing a track record of competent performance in important activities. This begins with convincing officials that amateurs offer a cost-effective (otherwise known as free) substitute for functions previously paid for by the taxpayer. Local radio amateurs also must demonstrate that they are organized, disciplined and reliable, and have a sincere interest in public service.

The most effective way to accomplish this is for you, as head of your communications group, to initiate the contact with public safety agencies in an official capacity. This is better than having individual amateurs, particularly outside an organized structure, making uncoordinated and poorly prepared contacts that often result in an impression that your group is disorganized.

Approach that first meeting well-prepared, and give a concise presentation of Amateur Radio's capabilities. Illustrate accomplishments with newspaper clippings, *QST* articles, etc, highlighting Amateur Radio public service. Discuss the existing Amateur Radio structure, emphasizing that a certain number of qualified operators will be able to respond to the public's needs.

Demonstrate the reliability and clarity of amateur gear. Nothing is more impressive than asking for a roll call on a 2-meter repeater using a hand-held radio in the police or fire chief's office and having amateurs respond with full-quieting signals from locations where municipal radios are normally ineffective. Such a demonstration several years ago convinced officials in Laguna Beach, California, to ask for the assistance of the South Orange County ARES. The wisdom of this decision became evident a short time later when that seaside resort community was hit by a series of local emergencies.

Suggest specific ways in which amateurs can be of assistance. Indicate you are aware that police and fire radio frequencies are usually saturated with tactical or operational traffic in emergencies, and offer to provide an administrative frequency for use in overall management and coordination of the relief effort. More importantly, offer to demonstrate what you are capable of doing by supplying a demonstration of your communications capabilities. It is of tremendous importance that you emphasize that the services supplied by your group will free public-safety officers for other duties.

Demonstrate how easily amateurs and their equipment can interface with public-safety efforts. A perfect way to do this is to demonstrate equipment that can be made operational quickly inside the headquarters building, in a mobile command post or in field units.

Express your group's willingness to meet the needs of the sponsor or agency you are dealing with. Show a readiness to provide training to your membership. Offer public-safety officials the opportunity to have their own representatives appear before your group and provide orientation and training they feel is essential.

Finally, be realistic and objective in terms of what your group promises to provide. Be fully prepared to keep all promises you make. Remember to be organized and competent. Once you have implemented these suggestions, be patient. The requests for your services will be forthcoming, perhaps in a volume you had not anticipated!

Grass-roots action is the name of the game when it comes to achieving effective liaison. With the proper ground work accomplished in advance, recognition among those sponsors and agencies having communications needs can be dramatically increased. It's symbiotic; these people need us, and we want to help. Now that all the necessary introductions have been made, the rest is easy, for we are indeed the experts in meeting communications requirements of every sort.

# ARES Chapter Seven

## On Serving “Served” Agencies

Meeting the communications needs of “served” agencies is a challenging, and often daunting proposition in today’s complex disaster/emergency relief arena. With the proliferation of emergency relief organizations, increasingly sophisticated needs, all competing for that scarce resource—the volunteer—coupled with the emergence of other non-ARES amateur providers, it’s enough to make an ARES member’s head spin. As more of the population moves to disaster-prone areas, and less government funding is available, more pressure is consequently placed on agencies to use (and sometimes abuse) the volunteer sector for support of their missions in disaster mitigation. Toes are sometimes stepped on and volunteer morale can be undermined.

On the other hand, the League’s formal relationships with served agencies are vitally important and valuable to radio amateurs. They provide us with the opportunity to contribute meaningfully to the relief of suffering among our fellow human beings. Another substantial benefit not to be overlooked is that these relationships lend legitimacy and credibility for Amateur Radio’s public service capability, and that is important when it comes time to defend our frequencies and privileges before the FCC and Congress, an ever more challenging task. So, ARRL’s relationships with the emergency/disaster relief world are to be nurtured.

### *7.1 What to Do?*

First, it is imperative that a detailed local operational plan be developed with agency managers in the jurisdiction that set forth precisely what each organization’s expectations are during a disaster operation. ARES and agency officials must work jointly to establish protocols for mutual trust and respect. Make sure they know who the principle ARES official is in the jurisdiction. All matters involving recruitment and utilization of ARES volunteers are directed by him/her, in response to the needs assessed by the agency involved. Make sure ARES counterparts in these agencies are aware of ARES policies, capabilities and perhaps most importantly, resource limitations. Let them know that ARES may have other obligations to fulfill with other agencies, too. Technical issues involving message format, security of message transmission, Disaster Welfare Inquiry policies, and others, should be reviewed and expounded upon in the detailed local operations plans.

### *7.2 Pulled Every Which Way But Loose*

Another challenge ARES faces is the number of agencies that demand communications support during a disaster. A local ARES unit only has so much to go around, and it can’t possibly meet every agency’s needs.

While the League maintains several formal Memoranda of Understanding (MOUs) with disaster and emergency response agencies including the Federal Emergency Management Agency, National Weather Service, Red Cross, Salvation Army, National Communications System, and Associated Public Safety Communications Officers, these documents merely set forth a framework for possible cooperation at the local level. While they are designed to encourage mutual recognition, cooperation and coordination, they should not be interpreted as to commit, obligate or mandate in any way that an ARES unit *must* serve a particular agency, or meet *all* of its needs, in a jurisdiction. MOUs

are “door openers,” to help you get your foot in the door—that’s all. It’s up to you to decide whether or not to pursue a local operational plan with an agency, a decision that will be based on a number of factors including the local needs of the agency and the resources you have available to support those needs, given that you may have other prioritized commitments as well.

To address this, sit down with your fellow ARES members, EC and SEC, and determine what agencies are active in your area, evaluate each of their needs, and which ones you are capable of meeting. Then prioritize these agencies and needs. After you’re all in agreement, sit down with your counterparts in each of the agencies and execute local, detailed operational plans and agreements in light of your priority list based on the above.

Given the above, however, you should also be working for growth in your ARES program, making it a stronger, more valuable resource and hence able to meet more of the agencies’ local needs. There are thousands of new Technicians coming into the amateur service now that would make ideal additions to an ARES roster. These new Technicians have hand-holds and a strong interest in emergency communications and public service. They’re ripe for picking for an active ARES program! A stronger ARES means a better ability to serve your communities in times of need and a greater sense of pride for Amateur Radio by both amateurs and the public. That’s good for all of us.

### *7.3 Another Kind of Competition*

With a strong ARES program, and a capability of substantially meeting most of the local served agencies’ needs, you might avoid another problem that is cropping up in some parts of the country, that of “competition” with emerging amateur groups providing similar communications services outside of ARES. Some of these groups may feel that their local ARES doesn’t do the job, or personality conflicts and egos get in the way, so they set up shop for themselves, working directly with agency officials, and usurping ARES’ traditional role. Some agencies have been receptive to their assistance.

There continues to be “RACES versus ARES” polarization in some areas. And some agencies, including at least one with statewide jurisdiction, are forming their own auxiliary communications groups, and recruiting their own hams, some away from ARES.

There’s not much you can do about this, except to work to find your ARES program’s niche and provide the best services you can as outlined above. Strive for growth and enhancement of ARES members’ abilities, and make sure you present a “professional” face to potential “served” agencies and your opportunities will grow. Make your program better than the next guy’s, and agencies will be more attracted to you.

If possible, setting egos and personalities aside, seek out these other groups and take the initiative to try to establish a rapport, and the fact that “we’re all in this *together*,” for the good of the public and Amateur Radio. With good communication, mutual respect and understanding between you and the other groups, at the least, you should be able to coordinate your program’s missions with theirs (i.e., divide up the pie, or who will do what for which agency) to foster an efficient and effective Amateur Radio response overall. At best, you may find other groups willing to fold their tents and join your camp! Try it.



# Section II: The National Traffic System (NTS)



# NTS Chapter One

## The National Traffic System

The National Traffic System plan is a means for systematizing amateur traffic handling facilities by making a structure available for an integrated traffic facility designed to achieve the utmost in two principal objectives: rapid movement of traffic from origin to destination, and training amateur operators to handle written traffic and participate in directed nets. These two objectives, which sometimes conflict with each other, are the underlying foundations of the National Traffic System.

NTS operates daily, even continuously, with the advent of the advanced digital links of today.

The personnel consists of operators who participate for one or two periods a week, and some who are active daily. The National Traffic System is an organized effort to handle traffic in accordance with a plan that is easily understood, is basically sound, and employs modern methods of network traffic handling in general acceptance today.

NTS is not intended as a deterrent or competition for the many independently organized traffic networks. When necessitated by overload or lack of outlet for traffic, the facilities of such networks can function as alternate traffic routings where this is indicated in the best interest of efficient message relay and/or delivery.

One of the most important features of NTS is the “system concept.” No NTS net is an independent entity that can conduct its activities without concern for or consideration of other NTS nets. Each net performs its function and only its function in the overall organization. To whatever extent nets fail to perform their functions or perform functions intended for other nets, to this extent is the overall system adversely affected.

Nets may sometimes find it necessary to adopt temporary expedients to ensure the movement of traffic, and this is considered improper operation only when no attempt is made to return to the normal schedule. Nevertheless, improper operation of any NTS net is the concern of all NTS nets, and every effort should be made to assist in returning any non-functioning or improperly functioning net to its normal operation.

### 1.1 Membership in NTS

Individual station participation in NTS is recognized by issuance of certificates, and by appointment to the field organization’s traffic handling position, entitled *Official Relay Station*. Organizationally speaking, the “members” of NTS are the nets and digital nodes which participate therein. Most such nets and many of the NTS-sanctioned nodes were created and organized for NTS purposes only and operate for specific purposes to be described later. Procedures are somewhat specialized, particularly at Region, Area and TCC levels.

Frequently, ARRL Headquarters is asked how a net or digital node (BBS) may become a part of NTS. This usually isn’t easy, because NTS is not a “club for nets” which any existing net may join at will. In addition, making nets a part of NTS is less a matter of official action than a “state of mind” of the net itself. In this connection, the following points deserve mention:

1. Nets or packet nodes (BBS’s) operating within ARRL section boundaries, or otherwise at local or section level, may become a part of NTS by performing

the functions of such.

2. Nets whose coverage extends beyond section boundaries but within region (roughly, call area) boundaries may become a part of NTS only by foregoing their general membership and setting up to operate as a session of the region net. Such nets would act as one of that region's net sessions and would be under the jurisdiction of the region net manager appointed by ARRL. All present NTS region nets were organized specifically at the outset for NTS region coverage.

3. HF digital stations capable of storing-and-forwarding NTS messages in a system of such stations may be certified as NTS Digital Stations by NTS Officials known as Area Digital Coordinators. They are responsible for handling NTS traffic to the same high standards as their counterparts in the traditional system.

4. Since operation at the area level is so specialized, it is not possible for nets whose coverage extends beyond region boundaries to be a part of NTS at any level.

5. Any net or digital node, which becomes a part of NTS, is expected to observe the general principles of NTS procedures.

6. Generally speaking, participation in NTS is best performed by individual-station participation in an already-existing NTS net, at any level.

7. Lack of recognition as an NTS net does not imply that such a net is without ARRL recognition or support. Many public service nets on which information is received are included in the League's *Net Directory*, and activities are often summarized in the appropriate part of *QST*. Although NTS is the League-sponsored organization for systematic traffic handling, it is far from being the League's only interest in public service communication.

### 1.2 Mode

The National Traffic System is not dedicated specifically to any mode or to any type of emission, nor to the exclusion of any of them, but to the use of the best mode for whatever purpose is involved. The aim is to handle formal written traffic systematically, by whatever mode best suits the purpose at hand. Whether voice, CW, RTTY, AMTOR, packet or other digital mode is used for any specific purpose is up to the Net Manager or Managers concerned and the dictates of logic. There is only one National Traffic System, not separate systems for each mode. Modes used should be in accordance with their respective merits, personnel availabilities and liaison practicalities. Whatever mode or modes are used, we all work together in a single and thoroughly integrated National Traffic System.

# NTS Chapter Two

## Principles of NTS Operation

The National Traffic System includes four different net levels that operate in an orderly time sequence to effect a definite flow pattern for traffic from origin to destination. A message flows through the National Traffic System in a manner similar to an airline passenger who starts out in a small residential town with a destination across the continent in another small town. He has to change carriers many times in the process, starting with a local ground conveyance to a

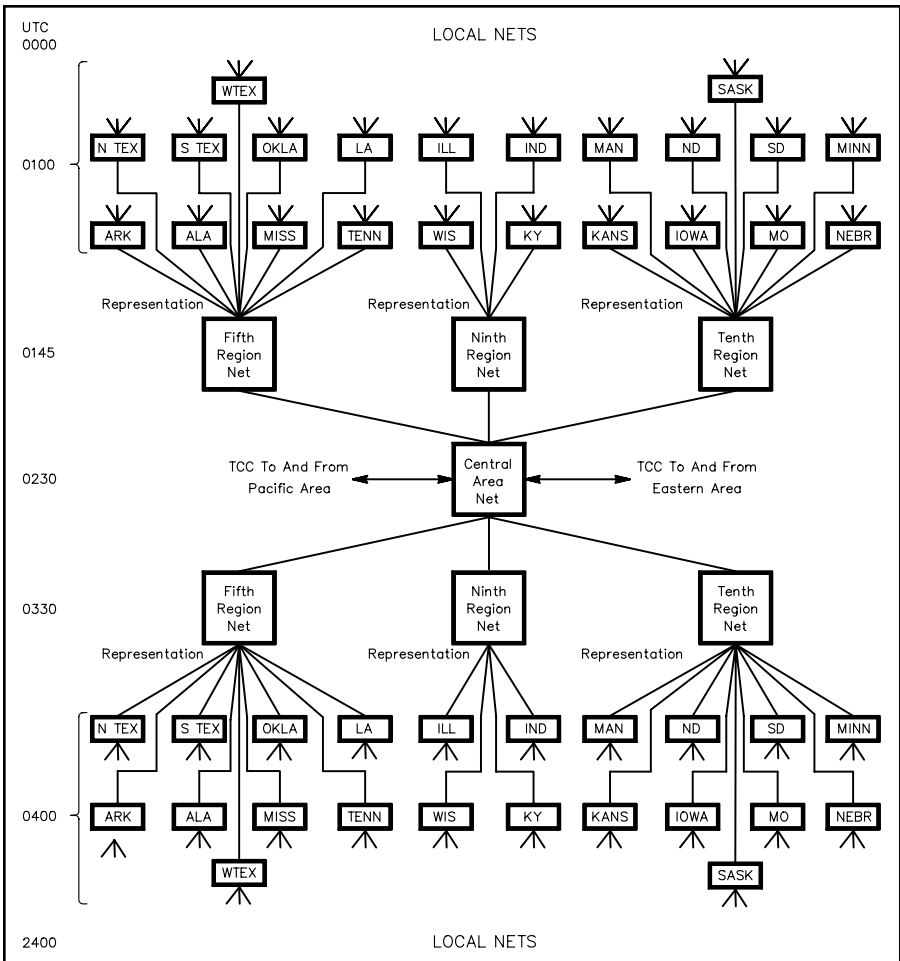

Fig 3—Organization chart for the evening cycle four NTS setup in the Central Area, showing times of net meetings at the various levels in NTS. Note that many of the early and late functions of local nets are combined at 2400/0000. Some of the other net echelons have alternatives not shown above.

feeder airline, to a transcontinental airline, to another feeder airline, then local transportation to deliver him to his destination. In a very similar manner, the transcontinental message starts with the originating station in a local net, is carried to the section net, the region net, the area net, via Transcontinental Corps (TCC) to a distant area net and then back down the line to delivery.

Of course the message, like the passenger, can “get on” or “get off” at any point if that’s the origin or destination. Thus, a message from, say, New York to Detroit would never get on TCC, but would “get off” at area level. A message from San Francisco to Los Angeles would not go beyond region level, and one from Syracuse to Buffalo would remain inside the section net.

Messages may also be passed through NTS-affiliated Local and Section traffic nodes that employ digital modes such as AMTOR and packet, with store-and-forward capabilities and bulletin board operations. Long hauls can be made by NTS Digital Stations at HF, that interface with Section traffic nodes, and the traditional nets of the system.

### *2.1 Local Nets*

Local nets are those that cover small areas such as a community, city, county or metropolitan area, not a complete ARRL section. They usually operate by VHF (typically 2-meter FM) at times and on days most convenient to their members; some are designated as “emergency” (ARES) nets that do not specialize in traffic handling. The time slot designated for them is thus nominal and will vary considerably. Local nets are intended mainly for local delivery of traffic, inasmuch as such delivery could ordinarily be effected conveniently by non-toll telephone. Some NTS local nets operate on a daily basis, just as do other nets of the system, to provide outlets for locally originated traffic and to route the incoming traffic as closely as possible to its actual destination before delivery—a matter of practice in a procedure that might be required in an emergency.

Most local nets and even some section nets in smaller sections use repeaters to excellent effect. Average coverage on VHF can be extended tenfold or more using a strategically located repeater, and this can achieve a local coverage area wide enough to encompass many of the smaller sections. Since propagation conditions on the high frequencies are erratic, more use of VHF and repeaters is recommended at local levels.

A local net, or “node,” may also be conducted on a local packet BBS, where radiograms may be stored, forwarded and picked up by local operators for delivery. A Net (Node) Manager is appointed by the Section Traffic Manager to manage these functions, and assure that traffic is moved expeditiously in accordance with basic NTS principles, just like their counterpart nets on local repeaters.

### *2.2 Section Nets*

Organizational and procedural lines begin to tighten at the section net level. Coverage of the section may be accomplished either by individual stations reporting in, by representatives of NTS local nets and nodes, or both. Ordinarily, all section amateurs are invited to take part; however, in a high-population section with several metropolitan areas covered by local nets, representation may be by such liaison stations plus individual stations in cities or towns not covered by local nets.

The section may have more than one net (a CW net, a VHF net, an SSB net, or even a section packet BBS, for examples), or two or more sections may combine to form a single net operating at section level, if low population or activity seem to make this desirable. Section nets are administered through the

office of the Section Manager, with authority for this function often delegated to an appointed Section Traffic Manager and/or designated Net Managers. In the case of combined-section nets, officials of the sections concerned should collaborate on the designation of a qualified amateur to manage the net. The purpose of the section net is to handle intra-section traffic, distribute traffic coming down from higher NTS echelons, and put inter-section traffic in the hands of the amateur designated to report into the next-higher NTS (region) echelon. Therefore, the maximum obtainable participation from section amateurs is desirable.

### *2.3 Region Nets*

Region nets cover a wider area, such as a call area. At this level the object is no longer mass coverage, but representation of each ARRL section within the region. Participants normally include:

1. A net control station, designated by the region net manager.
2. Representatives from each of the various sections in the region, designated by their section net managers.
3. One or more stations designated by the region net manager to handle traffic going to points outside the region.
4. One or more stations bringing traffic down from higher NTS echelons.
5. Any other station with traffic.

There may be more than one representative from each section in the region net, but more than two are usually superfluous and will only clutter the net; however, all section representatives are required to represent the entire section, not just their own net.

The purpose of the region net is to exchange traffic among the sections in the region, put out-of-region traffic in the hands of stations designated to handle it, and distribute traffic coming to the region from outside among the section representatives. Region nets are administered by managers appointed by the Field Services Manager at ARRL Headquarters.

### *2.4 Area Nets*

At the top level of NTS nets is the area net. In general, the area net is to the region net what the region net is to the section net; that is, participation at area level includes:

1. A net control station, designated by the area net manager.
2. One or more representatives from each region net in the area, designated by the region net managers.
3. TCC stations designated to handle traffic going to other areas.
4. TCC stations designated to bring traffic from other areas.
5. Any station with traffic.

Points (3) and (4) are functions of the Transcontinental Corps, to be described later. There are three areas, designated Eastern, Central and Pacific, the names roughly indicating their coverage of the US and Canada except that the Pacific Area includes the Mountain as well as the Pacific time zones. Area nets are administered by managers appointed by the ARRL Field Services Manager.

### *2.5 Transcontinental Corps*

The handling of inter-area traffic is accomplished through the facilities of the TCC. This is not a net, but a group of designated stations who have the responsibility for seeing that inter-area traffic reaches its destination area. TCC is

administered by TCC directors, or as delegated to the Area Digital Coordinator, in each area who assign stations to report into area nets for the purpose of “clearing” inter-area traffic, and to keep out-of-net schedules with each other for the purpose of transferring traffic from one area to another.

### 2.6 Digital Stations

The handling of traffic among sections, regions and areas can also be accomplished alternatively, on a supportive/cooperative basis, through liaison with the traditional aspects of the system, by the set of NTS Digital Stations across the country. These stations, certified by their respective Area Digital Coordinators, handle traffic by digital modes at HF. The system structure is more loosely defined than is the traditional system. They serve to supplement the existing system, providing options, and flexibility in getting traffic moved expeditiously across the country, especially in overload conditions.

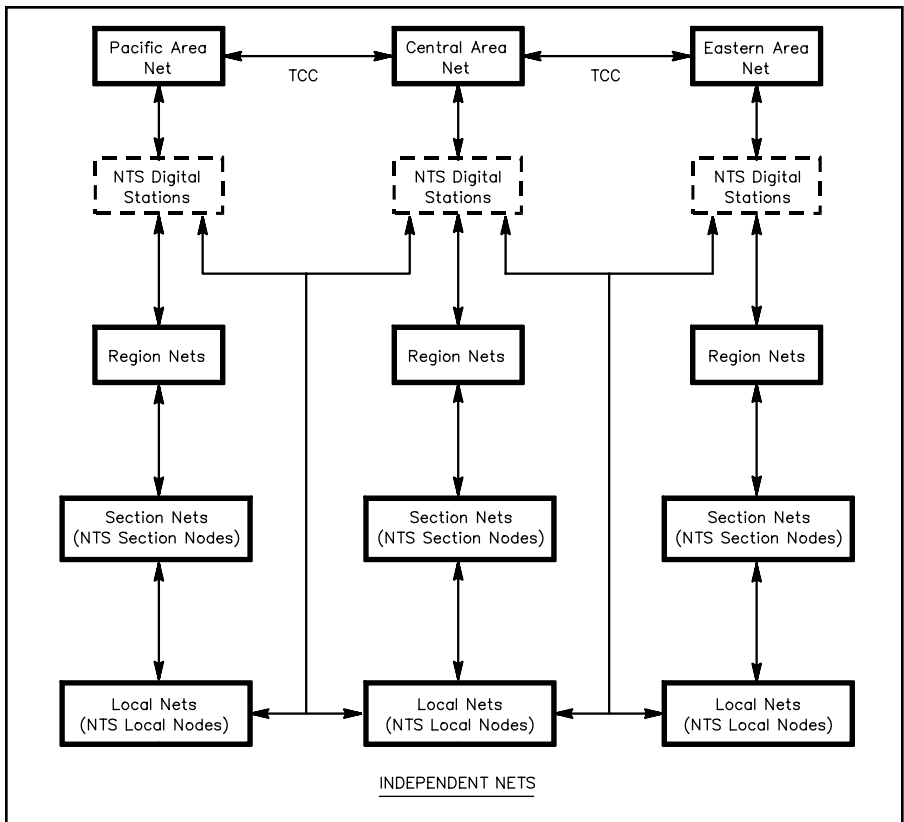

Figure 4 — NTS organization chart showing NTS-certified Digital Stations and Section and local packet traffic nets/nodes as integrated, alternative routing options.

# NTS Chapter Three

## NTS Policies

### 3.1 Sequence of Net Meetings

The order in which the various nets meet is essential to the proper operation of the system. The effectiveness of the National Traffic System depends on a delicate balance of voluntary cooperation and adherence to established procedures. Accordingly, in 1979, the NTS Area Staffs jointly recommended a symmetrical, four-cycle NTS net sequence, which is now the formal system definition for voice and CW modes.

Cycles Two and Four are, at this time, implemented in all three areas. In addition, Cycle One is implemented in the Pacific Area, and Cycle Three is implemented in the Eastern Area to facilitate intra-area and west-to-east traffic flow. Cycles One and Three were initially designed for high-volume situations to improve and enhance the response of NTS to emergency and overload situations. However, the entire four-cycle sequence can, if need be, be activated in three-hour shifts when needed.

A few features of NTS structure may need some elaborating. The primary function of TCC is to link the activated cycles. The schedule plan calls for each area net (PAN, CAN, EAN) to hold a session per day at 11:30 AM, 2:30 PM, 5:30 PM, and 8:30 PM local time, and a maximum of 60 minutes allotted to them, to clear inter- and intra-area traffic. The system is symmetrical, regular and repeatable. This means, first, that the structure of the net sequencing is consistent from area to area, and second, that a net session occurring at a given local time in the Eastern area should subsequently occur at the corresponding local times in the Central and Pacific areas.

Expansion of the four-cycle system schedule for emergencies and emergency-preparedness exercises, such as SET, augment the basic cycles. More importantly, normal daily sessions of nets at all levels of the system (ideally) remain intact during emergency operations. Expansion of the system during overloads is simple, involving a duplicate of the existing schedule, slid over an adjacent three hour period. Potential new area net sessions can be held, along with their associated region, section and local nets. Minimum implementation currently consists of Cycles Two and Four.

Traffic from EAN to CAN is handled by direct check-in into CAN by the TCC operator. Many of the other TCC functions are out-of-net schedules, allowing optimum choice of band and mode to fit varying propagation conditions and operator preference. The time between the end of the Cycle Two PAN session and the start of the Cycle Four EAN session allows for an out-of-net TCC sked followed by direct section net check-in on the East Coast, to speed up the

**Table 2**  
**NTS Net Schedule**

<i>Cycle One</i>	<i>Cycle Three</i>
10:00 AM Section	4:00 PM Section
10:45 AM Region	4:45 PM Region
11:30 AM Area	5:30 PM Area
12:30 PM Region	6:30 PM Region
<i>Cycle Two</i>	<i>Cycle Four</i>
1:00 PM Section	7:00 PM Section
1:45 PM Region	7:45 PM Region
2:30 PM Area	8:30 PM Area
3:30 PM Region	9:30 PM Region
	10:00 PM Section



same-day delivery service. TCC skeds are from one cycle to the same cycle for westbound traffic, or from one cycle to the next cycle for eastbound traffic. That is to say, TCC functions, which bring traffic from the West Coast to the East Coast, for example, connect the daytime PAN session with evening nets in the east, or the evening PAN session with the first next day EAN sequence. The significance of this concept is that it combines the discipline and training of a predetermined schedule, with the spontaneous determination of the level of activity required for any specific emergency exercise.

The original goals of the four-cycle plan are as follows:

1. Make daytime and evening NTS part of a single, unified system.
2. Resolve net time conflicts between areas.
3. Enhance daytime/evening participation. TCC functions provide daytime/evening crossovers, so that traffic is delivered in the next available cycle of NTS, regardless of time of day or mode.
4. The system will be consistent from area to area, from cycle to cycle.
5. Evening participants will understand (and support) the daytime cycle and vice versa, with no additional training.
6. No traffic will be compromised for any other traffic by irregular net sequencing.

### *3.2 Options*

NTS is a volunteer traffic system, and it is not always practical to find traffic stations able to participate in nets at various levels at particular times. While in principle NTS nets find the personnel who can participate at the time designated, rather than change the time to suit the personnel, there is occasionally a necessity for a certain amount of non-uniformity in net meeting time, and options may be used at the discretion of the net manager. However, any such options are to be considered temporary and a return to normal NTS-recommended operating times should be made as soon as possible.

Whenever changes from normal routings and sequences are made, the appropriate Area Staff Chairman and Headquarters should be notified so that accurate net information will be available at a centralized point. In NTS, the right hand should always know what the left hand is doing. No NTS net should consider itself independent of or unconcerned with the functioning of other parts of the system.

### *3.3 Deviation from Normal Routing*

Failure to use the normal routings described above, if carried to the extreme, will result in "strangulation" of one or more NTS nets at region or area level. That is, if section nets send representatives to other section nets to clear traffic direct instead of through the region net, the region net will "starve" for traffic. Similarly, if region nets maintain liaison with each other direct instead of through the common medium of the area net, the latter will have little traffic and will not prosper. It is in the interest of efficiency, organization, system, training and conservation of skilled personnel to use the NTS structure as it is intended to be used. Let's not be ridiculous, however. Those who would follow the system to the letter are occasionally guilty only of unnecessarily delaying delivery.

Any station in NTS, regardless of the function the operator performs, who receives a message destined to a point in his local calling area, should deliver that message rather than filter it further through the system. There are many metropolitan areas which straddle NTS net coverage boundaries but have common toll-free telephone coverage.

### *3.4 Adherence to Schedules*

Since NTS depends for its efficiency on chronology of net meetings, it naturally follows that adherence to NTS schedules is of the greatest importance. In particular, TCC and liaison stations should not be held on any NTS net beyond the time they are scheduled to meet another net, even if all their traffic has not yet been cleared. Leftover traffic should be held, put on alternate routes including the NTS Digital Station network, or handled by special schedule later.

Along the same line, NTS nets should not operate beyond the time allotted to them. The time sequence in Table 2 shows the normal length on nets at various levels.

### *3.5 Alternate Routings*

Deviations are made from normal routings only when normal channels are for some reason not available. A return to the use of normal NTS channels should be made as soon as possible. The net manager shall be the judge as to whether normal facilities are available, satisfactory or adequate in making any deviations. Alternate routings, if and when necessary, can include regular or specially arranged schedules, direct liaison to the NTS destination net, or use of the facilities of independent and NTS Digital Station networks.

### *3.6 Check-In Policy*

National Traffic System nets at local and section level are open to all amateurs in the coverage area of the net. At region and area level, participation is normally restricted to representatives of sections, and designated liaison stations. However, stations from outside the coverage area of the net concerned, or other not-regularly designated participants who report in with traffic will be cleared provided they can maintain the pace of the net as to procedure, speed and general net "savvy." Such stations reporting in without traffic will immediately be excused by the NCS unless they can supply outlets unavailable through normal NTS channels. Visitors to NTS nets should bear in mind that NTS nets operate on a time schedule and that no offense is intended in observance of the above check-in policy.

### *3.7 Boundaries*

NTS net coverage areas are strictly defined and strictly observed in daily operation of the system, at section level, by ARRL section boundaries, at region level in accordance with the grouping of the sections into NTS regions based originally on call areas. Some of the regions are on call area basis (First, Second, Third, and Eighth), but others cover parts of two or more call areas. At area level the original basis was standard time zones, and the boundaries still roughly follow these lines without dividing any sections. The NTS routing guide gives details of boundaries of the various NTS echelons of operation.

Sections can be changed from one region to another at the request of the section leadership provided no disruption of the system's operation is involved. Normally, such requests will be considered only for sections located on boundary lines between regions. The time zone in which a section or region is located or mostly located exerts a strong influence in its assignment to a region and area.

The NTS HF Digital Station network is organized loosely along Area lines, with an Area Digital Coordinator in charge of the NTS Digital Stations in his/her Area.

### *3.8 Nomenclature*

NTS nets at region and area level officially carry the name of the region or area they cover (Sixth Region Net, Pacific Area Net, etc.). Net “designations” at these levels vary somewhat (First Region Net is 1RN, Fifth Region Net is RN5, Twelfth Region Net is TWN and Eleventh Region Net, the only Canadian region net, calls itself Eastern Canada Net and uses the designation ECN). Section nets customarily carry the name of the section or sections they cover, but the actual name used is optional with the net. Some examples are Pine Tree Net (Maine), Buckeye Net (Ohio) and Northern California Net (five California Sections).

### *3.9 Combined Section Nets*

Some ARRL sections, which have little or no traffic interest have not organized section nets, while in some cases two or more sections have combined their facilities into a single net operating at section level. This latter practice is considered a desirable one where circumstances make it necessary and feasible, and such a combined-section net can participate in NTS in the same way as any other section net, with each representative representing both (or all) sections covered.

It is recommended that traffic handlers in sections, which do not at present boast a section traffic net or packet node, take steps to organize one for NTS representation. Lacking this, it might be possible to participate, temporarily at least, in the NTS net of an adjoining section, and be considered members of that section’s net until such time as it is feasible to establish one. Such an arrangement, of course, requires the approval of the SM, STM and net manager of the section net concerned.

### *3.10 Limited Load Capability*

Because the system operates on a time schedule with a definite flow pattern, NTS has difficulties under heavy load just as do all communications systems. Thus, in normal times, the system observes the “limited load” policy. It is the general policy of NTS to strive for handling the greatest quantity of traffic through efficiency rather than through long hours of operation. NTS nets must begin and terminate within certain time limits in order that liaisons can be maintained without delay. If traffic is not all cleared within the time limit, it is considered “overflow” traffic and must use alternative routings including the NTS Digital Station network or be held over.

Load capacity can be increased by providing additional stations to carry on liaison functions and TCC operations; by providing separate receive and transmit stations; and by pre-net sorting of traffic by region (outside the area of origination) and area, and concentrating the traffic in the hands of separate operators. This allows more expeditious operation in the area net. Use of liaison operators to the HF Digital Station network is also encouraged.

### *3.11 Observation of Time*

In order to avoid confusion and effect standardization, NTS nets should endeavor to meet at the times officially designated for them in this booklet. Where temporary departures are necessary, care should be taken that this will not adversely affect the traffic flow or cause interference to other NTS nets because of time differences.

### *3.12 Frequencies*

There is no specific NTS frequency plan. Each NTS net selects its own

operating frequency in consideration of its requirements. Because in an emergency it may be necessary to operate many NTS nets simultaneously which ordinarily operate at different times, it is desirable for nets within normal interference range of each other to use different center frequencies, if possible. Within this consideration, it is also desirable to concentrate NTS operation on as few spot frequencies as possible to conserve frequency space, and to make full use of those spot frequencies used in order to help establish occupancy. ARRL's *Net Directory* records net frequencies and times and is useful to study in planning new nets.

### 3.13 Manager Appointments

NTS net (packet node) managers at the local and section level are appointed or designated by the STM. All other NTS managers, including Area Digital Coordinators, are appointed by the Field Services Manager after recommendation from the area staff concerned and coordination with the STM or SM of the section in which the candidate resides. Net managers and Area Digital Coordinators are appointed for no specific term of office.

The Area Digital Coordinators are responsible for appointing the NTS Digital Stations at HF.

### 3.14 Certification

NTS certificates are available at local, section, region, and area levels as well as for fulfilling TCC assignments. A participating station is eligible for an NTS net certificate when it has completed three months of performance (at least once per week), on an assigned basis, of one or more of three essential duties:

1. Regular participation as a net station. In the case of region and area nets, this means official representation of a section or region within its respective region or area. No credit is given in region or area nets for random participation.

2. Liaison with other nets of the National Traffic System. This applies only to regular liaison in accordance with the NTS flow pattern as assigned by the appropriate net manager. In the case of section nets, liaison with their proper region nets; in the case of region nets, liaison with their proper area nets; in the case of area nets, liaison with other area nets through regularly assigned functions in the Transcontinental Corps.

3. Net Control Station.

Certification in the Transcontinental Corps is available through the TCC area director on completion of at least three months of regular performance of an assigned function.

Net Managers (or TCC directors) may use their discretion in "excusing" any station working for a certificate if that station is unable to perform its regular duty in any specific instance. Net managers (or TCC directors) shall be the sole judges as to whether a duty, even though performed regularly, is performed adequately to merit certification.

Area Digital Coordinators issue certificates to NTS HF Digital Stations.

### 3.15 Special Liaison Methods

Often managers at region and area levels will find that while one section or region can send few or no liaison stations, others have sufficient personnel to send several. In such cases, it is possible and perfectly permissible for the higher-level manager to propose to the lower-level manager to arrange that any excess personnel be used to effect liaison not being properly performed through lack of available stations. Example: The manager of the Umph Region Net finds that many stations are available to represent Section A in his region, but Section

B is seldom represented. He contacts the manager of the Section B Net and proposes that a Section A station be sent to the early meeting of Section B to take its "thru" (out-of-section) traffic. This station then brings such traffic to the Umph Region Net to be distributed among net stations as required. In addition, a Section A station in URN may be designated to receive all Section B traffic; this station then reports into the Section B Net to clear this traffic. Both receiving and sending functions must be completed for full representation. The above technique is an alternative method of getting the traffic through and is under no circumstances to be used in preference to having a station from the section itself report to the region net. Normally, liaison of a lower-echelon net to a higher-echelon net is the responsibility of the manager of the lower-echelon net.

# NTS Chapter Four

## Operation During Disasters

The National Traffic System is dedicated to communications during disasters on behalf of ARES, as well as the daily handling of third-party traffic. When a disaster situation arises, NTS is capable of expanding its cyclic operation into complete or partial disaster operation depending entirely on the extent of the disaster situation and the extent of its effect. The normal cycles may be expanded as required by the situation, so that more traffic can be handled and so that it can be handled more rapidly. In the extreme case, the cycles can operate continuously, with required representation present in all nets continuously, with stations designed for this function replacing each other as others are dispatched to the higher or lower nets with which they make liaison.

In a situation like this, who alerts or activates NTS nets in a disaster and who determines which net or nets should be activated? ARRL Emergency Coordinators in disaster areas determine the communications needs and make decisions regarding the disposition of local communications facilities, in accordance with the need and in coordination with agencies to be served. The Section Emergency Coordinator, after conferring with the affected DECs and ECs, makes his recommendations to the Section Traffic Manager and/or NTS managers at section and/or region levels. The decision and resulting action to alert the NTS region management may be performed by any combination of these officials, depending upon the urgency of the situation.

While the EC is, in effect, the manager of ARES nets operating at local levels, and therefore makes decisions regarding their activation, managers of NTS nets at local, section, region and area levels are directly responsible for activation of their nets in a disaster situation, at the behest of and on the recommendation of ARES or NTS officials at lower levels. The following “check lists” apply to officials at the levels indicated:

### *4.1 Section Traffic Manager, Section Net Manager Functions*

1. You may be contacted during a disaster situation by the SEC, to activate your section nets, whether NTS or not, either to provide section-wide contact or, in the case of NTS nets, to provide liaison with the “outside.” Have some means of activating your net(s) at any time. Make it understood in your net that in the event of a disaster, net stations should monitor the net frequency. Some net stations, at locations badly needed, can be activated by telephone if phone lines are available.

2. Make contact with your NTS region net managers in the event that communications connected with the disaster transcend section boundaries, recommending extraordinary activation of the region net. You should have some prearranged method of contact for this purpose.

3. Designate net stations to conduct liaison with the NTS region net, either through another section net or direct. This is your responsibility, not that of the region net manager.

### *4.2 Region Net Manager Functions*

1. Any one of the section officials in your region or another NTS region may contact you should a disaster situation develop. Try to predict such contact on the basis of circumstances and be available to receive their recommendation.

2. Make contact with your NTS area net manager in the event that communi-

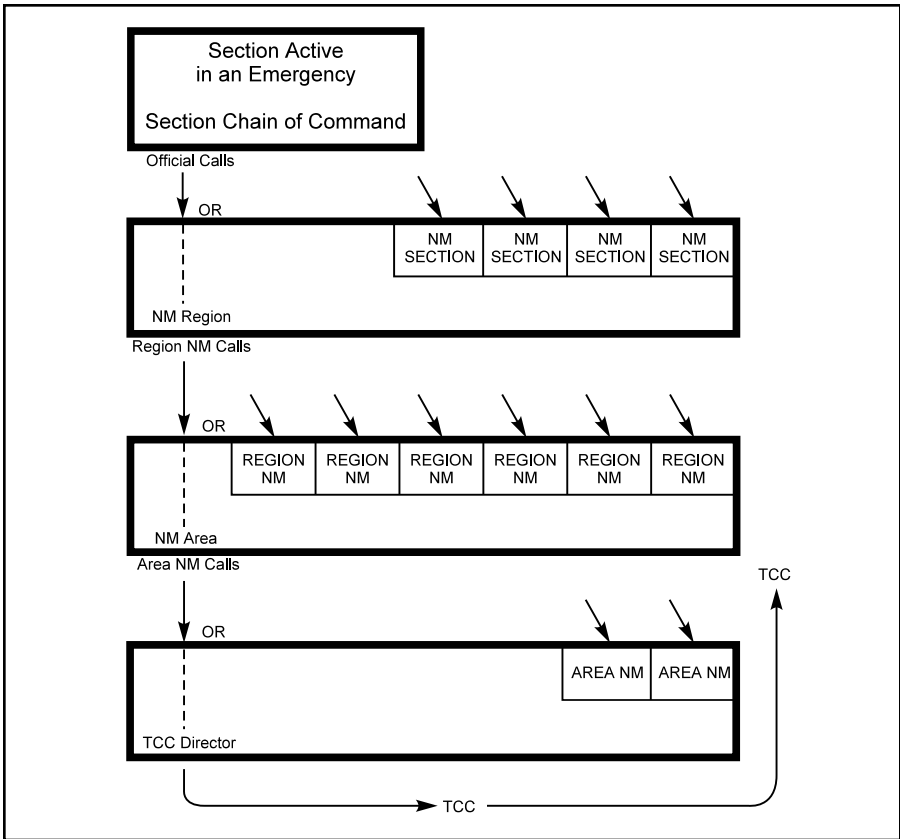

Fig 5—NTS alerting plan.

cations connected with the disaster transcend region boundaries, recommending extraordinary activation of the area NTS net. Have some prearranged method of contact for this purpose.

3. It is your responsibility to see that the region is represented in any extraordinary session of the area net, in addition, of course, to all regular sessions.

#### 4.3 Area Net Manager Functions

There are only two area net manager appointees for each area, but their function during and after disasters is of paramount importance.

1. Maintain a high sensitivity to disasters in your area which extend or may extend beyond region boundaries. When one does, take the initiative to alert the region net manager involved to determine if extraordinary NTS operation is indicated.

2. In the event high precedence inter-area traffic is involved, contact the two TCC directors in your area to assist in making arrangements to clear the traffic to other areas.

3. Contact other NTS area net managers to confer on possibilities of their having extra net sessions if deemed required to handle the traffic reaching them through NTS inter-area handling. Under some circumstances, direct representation or "hot lines" may be indicated.

4. Maintain close contact with all region net managers in your area and make decisions regarding overall NTS operation in consultation with them.

#### *4.4 Transcontinental Corps Director Functions*

These NTS officials will be involved only where traffic of a precedence higher than routine is to be handled between NTS areas, or when extreme overloads are anticipated.

1. Be ready to alert your TCC crew and set up special out-of-net schedules as required.

2. You may be called upon by the area net manager to set up “hot line” circuits between key cities involved in heavy traffic flow. Bear in mind which of your TCC stations are located in or near enough to large cities to man such circuits.

#### *4.5 Area Staff Chairmen Functions*

The three Area Staff Chairmen administratively oversee the NTS Officials and their operations, and will advise their TCC Directors, Area and Region Net Managers when appropriate. Their advice may be based on information forwarded by ARRL Headquarters.

1. Maintain a high sensitivity to disasters and other emergencies that may develop.

2. Contact the other Area Staff Chairmen via prearranged schedules.

#### *4.6 General Policy*

NTS operators should be self-alerting to disaster conditions that might require their services, and should report into an appropriately assigned net or other function without being specifically called upon. That is, the assignment should have been worked out with your net manager in advance. Each NTS operator should ask himself or herself: “What is my disaster assignment? If I hear of a disaster condition, what should I do?” If he/she cannot answer the question, he/she should seek an answer to it through his/her Net Manager. It may be as simple as “report into the X Net on X frequency.” If the operator concerned is highly specialized, it might be “report to your TCC director in the X net on X frequency for a special assignment.” Such an assignment might be an extra TCC function, or it might be as a functionary in a “hot line” point-to-point circuit needing special abilities or equipment.

Flexibility is needed, but a definite assignment pertaining to disaster operation is something that all NTS operators should have. If you don't have a specific assignment, push the matter with your net manager. NTS should be the front line of available Amateur Radio disaster communication.

#### *4.7 Health and Welfare Traffic*

One of the biggest problems in a disaster is the handling of so-called “health and welfare” traffic or “disaster welfare inquiries.” The ARRL-recommended precedence for this type of traffic is W or “Welfare,” and refers to either an inquiry as to the health and welfare of an individual in the disaster area or an advisory from the disaster area that indicates all is well. The influx of W traffic into the disaster area may be large, and NTS may be called upon to assist with this overload. The NTS policy with respect to the handling of W traffic is to handle as much of it as possible, but to adhere to its precedence. Higher-precedence traffic must be handled first, W traffic only when the circuit is free. Routine (R) traffic is not normally handled by an NTS net operating under disaster conditions, because usually they more than have their hands full with



higher precedence, but should a disaster circuit be temporarily available, there is no reason why it cannot be handled until the circuit again becomes occupied with higher-precedence traffic.

In a widespread disaster situation, it is seldom possible to handle all the Welfare traffic with efficiency and dispatch. Sometimes, in fact, such traffic piles up alarmingly, to the extent that much of it is never delivered. There are a number of ways in which this can be controlled, but few of them are consistent with public relations objectives. The best way to handle such situations is to maintain close contact with the Red Cross or the Salvation Army as appropriate, since most inquiries are handled through these organizations. Civil preparedness organizations also can often set up procedures for handling such traffic. In the past, special RTTY, ASCII, AMTOR and packet circuits have been established with great success. Until or unless means for handling such traffic are established, it is usually wisest not to accept it from the general public, or to do so only with an explicit understanding that chances of delivery are not guaranteed.

# NTS Chapter Five

## NTS Standard Net Procedures

The following procedures are recommended as NTS standards. Deviations from these procedures are made at the discretion of the net manager in cognizance of either necessity or desirability arising out of extraordinary circumstances, but always as a temporary expedient until standard procedure can be resumed. The following procedures apply to all NTS nets:

1. The net control station (NCS) transmits a net callup promptly at the pre-established net meeting time.
2. Stations reporting in indicate their function or the destination(s) for which they can take traffic, followed by the list of traffic on their hook, if any.
3. Time-consuming pleasantries and other superfluous matters are not to be a part of the procedure while the net is in session.
4. Net stations follow the direction of the NCS without question or comment if such directions are understood.
5. Explanations of any kind are not transmitted unless they are absolutely essential to the net's conduct.
6. Stations reporting into a net are held for 15 minutes, after which they are excused if there is no further traffic for them at that time. Stations in the net do not leave the net without being excused and do not ask to be excused unless absolutely necessary.
7. All nets follow the general precepts of net operation outlined in *The ARRL Operating Manual*.

### 5.1 Section Nets

The random call-up method should be used in most cases. The clearing of traffic should commence as soon as stations reporting in the net have traffic for each other, rather than waiting until all stations have reported in. The use of side frequencies (QNY) should be used extensively. The QNA procedure (stations answering in prearranged order) should only be used in times of traffic overload, or for acknowledging the region net representatives at the beginning of the net. The following additional procedures are used in Section Nets:

1. Stations reporting in to the net with traffic, list the destination city first, then the number of messages for that city. Example— "W2RQ DE AA2Z QTC Paterson 1 AR" Traffic destined outside the section is designated "through" (or "thru") followed by the number of "thru" messages. "Thru" traffic can also be listed for the appropriate region net.
2. The region net representative is selected beforehand by the section Net Manager, but nevertheless indicates his purpose in reporting in.
3. Stations do not list their traffic until first recognized by the NCS.
4. If a particular city for which there is traffic is not represented on the net, the NCS may inquire who will handle such traffic, direct that it be sent to the station who can take it to a local net or bulletin board for delivery, or who is nearest to the destination, or that it be mailed. In any case, there should be a minimum of discussion.

### 5.2 Region Nets

1. Stations reporting in indicate the section they came from if they are officially reporting for the purpose of handling traffic to or from that section. If

their function is limited to sending or receiving, they should so indicate; otherwise the NCS will assume the station will do both.

2. Traffic for destinations within the region is reported by section. If the destination is outside the region, the traffic should be designated “thru” or for the area net. For example, “DE W9QLW QIN QTC WIS 3 ILL 2 CAN 2 AR” tells the NCS that W9QLW represents the Indiana section (QIN), and has traffic.

3. The area net liaison station (designated beforehand by the region net manager) receives all traffic designated for the area net.

4. Stations reporting in who are not authorized section representatives or liaisons simply indicate the traffic they have to send. If they do not have any traffic, they are immediately excused by the NCS, unless they can provide an outlet not available on the net through regular NTS channels.

5. In the event that a particular section is not represented in the region net, the NCS will use special liaison methods or any alternatives that are available for clearing traffic to that section.

### *5.3 Area Nets*

1. Stations reporting in indicate traffic by region if it is destined for a region within that area or by area if it is destined to a point outside that area. All stations reporting in with assigned receive functions indicate for which region in the area or for which other area they are authorized to receive traffic.

2. The TCC representative designated to take traffic for another area so indicates in his QNI (check-in). For example, “DE W2MTA PAN QRU AR” tells the NCS that W2MTA has been assigned to take any traffic destined to the Pacific area and that he himself has no traffic.

### *5.4 Send and Receive Stations*

Many NTS nets have adopted the procedure of sending more than one representative to the next-higher NTS echelon—one to take the traffic up and report it in, another to receive traffic from the upper echelon and bring it back. More than one transmit or receive liaison may be provided if traffic load is heavy and the personnel available is sufficient. It is perfectly permissible, and has many advantages in overload conditions, to the NCS and the net, for traffic both going and coming to be divided among two or more liaison stations.

Representatives who do not indicate which function they are performing will be assumed to be ready to perform both transmit and receive functions, at the discretion of the NCS. To indicate which you are performing, on CW send RX or TX after your QNI; on phone, say “receive only” or “transmit only,” or “both.”

### *5.5 Miscellaneous Procedures*

1. When “QNY procedure” (dispatching stations to clear traffic on an adjacent or different frequency) is used, the station designated to receive traffic should call first, after zeroing on a spot near the QNY point comparatively free of QRM. When a two-way exchange is to be made on the net frequency, the station named first by the NCS is to call first.

2. In QNY procedure, (which should be used whenever traffic is heavy, if possible), the frequency designated by the NCS is not intended to be exact. NTS stations using this procedure will be careful not to disrupt other traffic nets or ongoing QSOs by carelessly plopping down and starting to call on the frequency. If QRM is heavy on the spot designated by the NCS, it is expected stations will attempt to find a spot nearby on which to clear their traffic rather than returning to net frequency without having cleared it.

3. It is not the policy for NTS nets to insist on a clear channel. Other stations operating on the frequency of an NTS net have a perfect right to be there. Net

control stations should not request such stations to move. If the net frequency is occupied at net starting time, the NCS should call the net on a nearby clear frequency.

#### *5.6 Section and Local NTS Traffic Nodes*

On a daily basis, under the direction of Net (Node) Managers appointed by the STM, "Net" members, including Official Relay Stations specializing in packet traffic handling, ensure that NTS traffic is forwarded properly, or remove traffic from the boards and either deliver it or bring it to Section- and Local-level NTS nets for handling.

#### *5.7 HF Digital Stations*

On a daily basis, under the direction of the Area Digital Coordinators, Digital Station operators ensure that traffic is forwarded properly, or is removed from the nodes and either delivered or relayed to the appropriate Area, Region, Section- and Local-level NTS nets for handling.

# NTS Chapter Six

## ARRL Precedences and Handling Instructions

All messages handled by Amateur Radio should contain precedences—that is, an evaluation of each message's importance, made by the originating station. A precedence is an "order of handling." There are four precedences in the ARRL message form: Emergency, Priority (P), Welfare (W) and Routine (R), in that order of handling. When and as they appear on a net or any other kind of circuit, messages will be handled in this order.

### 6.1 Emergency

Any message having life and death urgency to any person or group of persons, which is transmitted by Amateur Radio in the absence of regular commercial facilities. This includes official messages of welfare agencies during emergencies requesting supplies, materials or instructions vital to relief to stricken populace in emergency areas. During normal times, it will be very rare. On CW, RTTY, AMTOR and packet this designation will always be spelled out. When in doubt, do not use this designation.

### 6.2 Priority

Use abbreviation P on CW, RTTY, AMTOR and packet. This classification is for important messages having a specific time limit, official messages not covered in the emergency category, press dispatches and emergency-related traffic not of the utmost urgency.

### 6.3 Welfare

This classification, abbreviated as W on CW, RTTY, AMTOR and packet, refers to either an inquiry as to the health and welfare of an individual in the disaster area or an advisory from the disaster area that indicates all is well. Welfare traffic is handled only after all emergency and priority traffic is cleared. The Red Cross equivalent to an incoming Welfare message is DWI (Disaster Welfare Inquiry).

### 6.4 Routine

Most traffic in normal times will bear this designation. In disaster situations, traffic labeled Routine (R on CW, RTTY, AMTOR and packet) should be handled last, or not at all when circuits are busy with higher-precedence traffic.

The precedence will follow, but is not a part of the message number. For example, a message may begin with NR 207 R on CW, "Number Two Zero Seven, Routine" on phone.

### 6.5 Handling Instructions

Handling instructions (HX) are less used but quite useful in handling messages. They serve to convey any special instructions to handling and delivering operators. This "prosign," when used, is inserted in the message preamble between the precedence and the station of origin. Its use is optional with the originating stations, but once inserted is mandatory with all relaying stations. The following definitions apply:

**HXA**—(Followed by number) Collect landline delivery authorized by addressee within...miles. (If no number, authorization is unlimited.)

**HXB**—(Followed by number) Cancel message if not delivered within...hours of filing time; service originating station.

**HXC**—Report date and time of delivery (TOD) to originating station.

**HXD**—Report to originating station the identity of station from which received, plus date and time. Report identity of station to which relayed, plus date and time, or if delivered report date, time and method of delivery.

**HXE**—Delivering station get reply from addressee, originate message back.

**HXF**—(Followed by number.) Hold delivery until...(date).

**HXG**—Delivery by mail or landline toll call not required. If toll or other expense involved, cancel message and service originating station.

Example: NR 207 R HXA50 W4MLE 12...(etc.).

If more than one HX prosign is used, they can be combined if no numbers are to be inserted, otherwise the HX should be repeated thus: NR 207 R HXAC W4MLE...(etc.). On phone, use phonetics for the letter or letters following the HX, to ensure accuracy.

# NTS Chapter Seven

## Operation of the Transcontinental Corps

The purpose of the Transcontinental Corps (TCC) is to relay traffic from one NTS area to another, conducting liaison with NTS nets to do so. Each NTS cycle has specific functionaries under the supervision of a TCC director.

The function of the TCC director is to assign functions, centralize, coordinate and supervise these activities and file status reports each month with ARRL Headquarters. There are six TCC directors, two for each area.

TCC functions are performed in several ways, according to circumstances. In many cases, the method used is an out-of-net schedule between TCC counterparts of different areas to effect the exchange of traffic from one area to another.

Times and frequencies of the schedules are worked out by the TCC directors working together and are arranged in accordance with time available, propagation conditions, stations available and other factors, always with the objective of the best service possible on an organized, systematic basis.

TCC stations must have the following qualifications:

1. Adequate signal power and appropriate mode to perform the job to be done.
2. The highest caliber of operating ability and NTS net savvy.
3. Capability (both operator and equipment) to keep the required schedules.

### *7.1 TCC Station Functions*

A TCC station might perform only one TCC function per week. On other days of the week, other stations perform the same function. TCC operates on a seven-day-per-week basis. Each function consists of two steps, as follows (all times in UTC):

#### **Station A**

1. Normally located in the Eastern Area, this station reports into Eastern Area Net at 0130, receives all traffic for the Central Area.
2. Reports into Central Area Net (CAN) the same night at 0230, distributes the traffic upon direction of the CAN control station.

#### **Station B**

1. Normally located in the Eastern Area, this station reports into Eastern Area Net (EAN) at 0130, receives all traffic for the Pacific Area.
2. Keeps a schedule with **Station H** some time between 0230 and 0430 and sends this traffic to him/her.

#### **Station C**

1. Normally located in the Central Area, reports into Central Area Net (CAN) at 0230, takes all traffic for the Eastern Area.
2. Keeps a schedule with **Station K** some time after 0330 and sends this traffic to him/her.

### **Station D**

1. Normally located in the Eastern Area, this station keeps a schedule with **Station J** some time between 0530 and 1930 to receive traffic for the Eastern Area.

2. Sends this traffic into destination Local, Section, Region or Eastern Area Nets at first opportunity.

### **Station E**

1. Normally located in the Central Area, this station reports into Central Area Net (CAN) at 0230, receives all traffic for the Pacific Area.

2. Keeps a schedule with **Station G** between 0330 and 0430 and sends this traffic to him/her.

### **Station F**

1. Normally located in the Central Area, this station keeps a schedule with **Station I** between 0530 and 2030 to receive traffic for the Central Area.

2. Sends this traffic into destination Local, Section, Region or Central Area Nets as soon as possible after received.

### **Station G**

1. Normally located in the Pacific Area, this station keeps a schedule with **Station E** between 0330 and 0430 to receive traffic for the Pacific Area.

2. Reports into the Pacific Area Net (PAN) at 0430 to distribute this traffic under direction of the PAN control station.

### **Station H**

1. Normally located in the Pacific Area, this station keeps a schedule with **Station B** between 0230 and 0430 to receive traffic for the Pacific Area.

2. Reports into the Pacific Area Net at 0430 to distribute this traffic under direction of the PAN control station.

### **Station I**

1. Normally located in the Pacific Area, this station reports into the Pacific Area Net (PAN) at 0430 to receive traffic for the Central Area.

2. Keeps a schedule with **Station F** between 0530 and 2030 to send this traffic.

### **Station J**

1. Normally located in the Pacific Area, this station reports into the Pacific Area Net (PAN) at 0430 to receive traffic for the Eastern Area.

2. Keeps a schedule with **Station D** between 0530 and 1930 to send this traffic.

### **Station K**

1. Normally located in the Eastern Area, this station keeps a schedule with **Station C** between 0330 and 1930 to receive traffic for the Eastern Area.

2. Sends this traffic into destination Local, Section, Region or Eastern Area Nets as soon as possible after received.

### **Station L**

1. Normally located in the Eastern Area, this station reports into Eastern Area Net (EAN) at 1930, receives all traffic for the Central Area.

2. Reports into Central Area Net (CAN) at 2030, distributes the traffic upon direction of the CAN control station.



### **Station M**

1. Normally located in the Eastern Area, this station reports into Eastern Area Net (EAN) at 1930, receives all traffic for the Pacific Area.
2. Keeps a schedule with **Station S** some time between 2030 and 2230 and sends this traffic to him/her.

### **Station N**

1. Normally located in the Central Area, reports into Central Area Net (CAN) at 2030, takes all traffic for the Eastern Area.
2. Keeps a schedule with **Station V** some time after 2130 and sends this traffic to him/her.

### **Station O**

1. Normally located in the Eastern Area, this station keeps a schedule with **Station U** sometime between 2330 and 0130 to receive traffic for the Eastern Area.
2. Sends this traffic into destination Local, Section, Region or Eastern Area Nets at first opportunity.

### **Station P**

1. Normally located in the Central Area, this station reports into Central Area Net (CAN) at 2030, receives all traffic for the Pacific Area.
2. Keeps a schedule with **Station R** between 2130 and 2230 and sends this traffic to him/her.

### **Station Q**

1. Normally located in the Central Area, this station keeps a schedule with **Station T** between 2330 and 0230 to receive traffic for the Central Area.
2. Sends this traffic into destination Local, Section, Region or Central Area Nets as soon as possible after received.

### **Station R**

1. Normally located in the Pacific Area, this station keeps a schedule with **Station P** between 2130 and 2230 to receive traffic for the Pacific Area.
2. Reports into the Pacific Area Net (PAN) at 2230 to distribute this traffic under the direction of the PAN control station.

### **Station S**

1. Normally located in the Pacific Area, this station keeps a schedule with **Station M** between 2030 and 2230 to receive traffic for the Pacific Area.
2. Reports into the Pacific Area Net at 2230 to distribute this traffic under the direction of the PAN control station.

### **Station T**

1. Normally located in the Pacific Area, this station reports into the Pacific Area Net (PAN) at 2230 to receive traffic for the Central Area.
2. Keeps a schedule with **Station Q** between 2330 and 0230 to send this traffic.

### **Station U**

1. Normally located in the Pacific Area, this station reports into the Pacific Area Net (PAN) at 2230 to receive traffic for the Eastern Area.
2. Keeps a schedule with **Station O** between 2330 and 0130 to send this traffic.

**Station V**

1. Normally located in the Eastern Area, this station keeps a schedule with **Station N** between 2130 and 0130 to receive traffic for the Eastern Area.
2. Sends this traffic into destination Local, Section, Region or Eastern Area Nets as soon as possible after received.

In addition, functions equivalent to the Q/T and O/T schedules are implemented in accordance with Cycle One in the Pacific Area. Further, the Atlantic Region Net (ARN) maintains liaison with EAN for the movement of international message traffic into and out of the NTS.

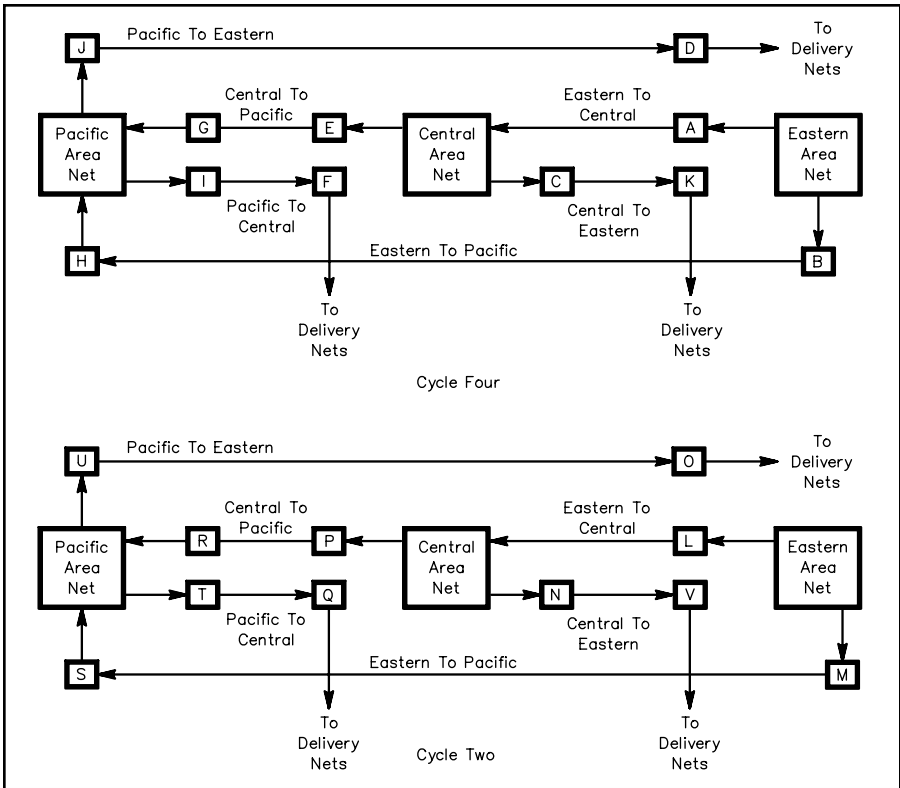

**Fig 6—How TCC works. Small blocks denote daily station functions, stations A and L being the only ones that report into an area net other than their own. Note that traffic from east to west goes into area nets while traffic from west to east may go into section or region nets to save time.**

# NTS Chapter Eight

## Operation of the Digital System

### 8.1 HF Digital NTS Operations

Radiogram-formatted NTS traffic on HF is being handled by digital means on the so-called “*APlink* system.” This system is a group of mailbox, store-and-forward (MBO) station operators spanning the country. Many of these stations have the capability of receiving and sending traffic via several digital modes including packet, by HF and VHF, all interchangeably. For example, a message received on HF Clover can be forwarded via VHF packet without modification. This flexibility is one of the system’s assets as it allows for forwarding along the best path at the time, resulting in the highest efficiency and reliability.

The chief concerns of the digital system, of course, are responsibility and accountability: Most MBO system operators are not concerned about NTS traffic that passes through their systems. Radiograms arriving at their stations are occasionally passed out the VHF port into the packet forwarding system with no guarantee that they will get to their destination. Many of these messages end up in the infamous “black hole” or “bit bucket.” Naturally, this violates the most basic principle of NTS: getting the message through all the way, from originator to addressee. What’s the answer? The solution is to introduce responsibility and accountability into the mix, just like we do with traditional NTS nets and operators.

Interested MBO system operators are now certified as “NTS Digital Stations” and as such, they accept responsibility for relaying traffic only to other NTS Digital Stations or NTS-approved nets or nodes. They are appointed by, and are accountable to, their Area Digital Coordinator, who is elected by the Area Staffs and who serves as an NTS Official and official member of the Area Staff. The ADCs maintain and publish a roster of these stations and report their activity to HQ. This way, the traffic stays “in the family,” giving it the best chance for proper delivery.

The network of NTS-approved HF Digital Stations is a mighty tool that, when used properly, can provide support to the traditional NTS nets, at any level. The digital network can pick up and move traffic when normal NTS nets cannot, due, for example, to an overloading situation, or lack of normal liaison operators.

### 8.2 VHF Packet Radio Bulletin Boards

NTS can take advantage of local packet radio bulletin boards for their ability in buttressing Local and Section NTS Nets and getting channels closer to traffic origination and destination points. Again, however, the concern is that traffic might end up in that “black hole,” mentioned above. Fortunately, many Section Traffic Managers have recognized this potential problem, and are working to ensure that packet BBSs (PBBS) are being cleared of radiogram NTS traffic each day. The most effective STMs have appointed “Net” Managers to manage the NTS element of these PBBSs. “Net” members, including Official Relay Stations specializing in packet traffic handling, ensure that traffic is forwarded properly, or remove traffic from the boards and either deliver it or bring it to Section- and Local-level NTS nets for handling. Some STMs have gone so far as to affiliate a major PBBS as an NTS Local or Section “Net.” If every Section were as vigilant, packet would be a more reliable resource for moving traffic expeditiously, and with accountability.

# NTS Chapter Nine

## NTS Traffic Routing

The following example shows how traffic is or can be routed through the National Traffic System. In each case, perfect (ideal) operating conditions and 100% adherence to system as previously outlined are assumed.

### 9.1 Example of NTS Message Routing

This example demonstrates how a message originating in South Carolina finds its way to Los Angeles in the evening cycle. W4ABC is an amateur in South Carolina who has been asked to originate a message to Los Angeles. All times are UTC, assuming local standard time is being observed throughout.

1. W4ABC reports the message into the South Carolina Section Net at 0000 and transmits it to W4ANK, the station designated to take traffic to 4RN.

2. W4ANK takes the message to 4RN at 0045, gives it to N4GHI, the station designated to take traffic to EAN.

3. N4GHI reports the message into EAN at 0130, gives it to W3PQ, who is TCC Station B.

4. W3PQ keeps a TCC out-of-net schedule with N6WP (TCC Station H) and sends him the message. This is a transcontinental hop, but the two stations involved may pick any frequency or mode in any band. The exchange must have been completed by 0430, when PAN meets.

5. N6WP reports the message into PAN at 0430, gives it to W6JXK, the RN6 (receive) representative.

6. W6JXK reports the message into RN6 at 0530, gives it to W6INH, the Los Angeles Section representative.

7. W6INH reports it into Southern California Net at 0600, gives it to K6INK, the Los Angeles station nearest the destination.

8. K6INK can telephone or otherwise deliver the message to the addressee upon receipt. The message originated in South Carolina at 0000, was delivered in LA at about 0630.

In addition to the NTS routing system, wide-coverage independent nets and direct connections to key cities in foreign countries are also available. These key cities, usually accessed through the independent nets, have been especially valuable in assisting with disaster communications in Central and South America. The independent nets take on a wide variety of types and forms with many of the most active heard daily on 40 and 20 meters. The 20-meter nets, particularly the International Assistance and Traffic Net, are especially important in covering the areas of the Caribbean, Central, North and South America.

### 9.2 NTS Routing Guide

<i>State/Province</i>	<i>Abbr</i>	<i>Region</i>	<i>Area</i>	<i>State/Province</i>	<i>Abbr</i>	<i>Region</i>	<i>Area</i>
Alaska	AK	7	PAN	Connecticut	CT	1	EAN
Alabama	AL	5	CAN	Delaware	DE	3	EAN
Alberta	AB	7	PAN	District of Columbia	DC	3	EAN
Arizona	AZ	12	PAN	Florida	FL	4	EAN
Arkansas	AR	5	CAN	Georgia	GA	4	EAN
British Columbia	BC	7	PAN	Guam	GU	6	PAN
California	CA	6	PAN	Hawaii	HI	6	PAN
Colorado	CO	12	PAN	Idaho	ID	7	PAN

<i>State/Province</i>	<i>Abbr</i>	<i>Region</i>	<i>Area</i>	<i>State/Province</i>	<i>Abbr</i>	<i>Region</i>	<i>Area</i>
Illinois	IL	9	CAN	Nova Scotia	NS	11	EAN
Indiana	IN	9	CAN	Ohio	OH	8	EAN
Iowa	IA	10	CAN	Oklahoma	OK	5	CAN
Kansas	KS	10	CAN	Ontario	ON	11	EAN
Kentucky	KY	9	CAN	Oregon	OR	7	PAN
Labrador	LB	11	EAN	Pennsylvania	PA	3	EAN
Louisiana	LA	5	CAN	Prince Edward Island			
Maine	ME	1	EAN		PE	11	EAN
Manitoba	MB	10	CAN	Puerto Rico	PR	4	EAN
Maryland	MD	3	EAN	Quebec	PQ	11	EAN
Massachusetts	MA	1	EAN	Rhode Island	RI	1	EAN
Michigan	MI	8	EAN	Saskatchewan	SK	10	CAN
Minnesota	MN	10	CAN	South Carolina	SC	4	EAN
Mississippi	MS	5	CAN	South Dakota	SD	10	CAN
Missouri	MO	10	CAN	Tennessee	TN	5	CAN
Montana	MT	7	PAN	Texas	TX	5	CAN
Nebraska	NE	10	CAN	Utah	UT	12	PAN
Nevada	NV	6	PAN	Vermont	VT	1	EAN
New Brunswick	NB	11	EAN	Virginia	VA	4	EAN
New Hampshire	NH	1	EAN	Virgin Islands	VI	4	EAN
New Jersey	NJ	2	EAN	Washington	WA	7	PAN
New Mexico	NM	12	PAN	West Virginia	WV	8	EAN
New York	NY	2	EAN	Wisconsin	WI	9	CAN
Newfoundland	NF	11	EAN	Wyoming	WY	12	PAN
North Carolina	NC	4	EAN	APO New York	APO NY	2	EAN
North Dakota	ND	10	CAN	APO San Francisco	APO SF	6	PAN

### 9.3 Message Routing in the Digital Station Network

In the HF system of NTS Digital Stations, routings are more flexible, and are left to the discretion of the individual mailbox operators, under the general direction of the Area Digital Coordinators. Routings should, of course, be planned with the goal of moving the traffic as close to its destination as quickly as possible, and/or to fill a liaison function that cannot be met in the traditional system. Routing should always be made with stations that can be relied upon to handle the traffic expeditiously and responsibly, under NTS official authority and direction.

The same principles apply to the VHF packet network of NTS nodes at the local and Section levels. It is the responsibility of the Section Traffic Manager and the Net (Node) Managers to ensure that NTS traffic is cleared, or otherwise forwarded or handled expeditiously, on a daily basis.

# NTS Chapter Ten

## Counting Net Traffic

### 10.1 Net Traffic Count

The basic count for traffic handled in nets is one point for each time a message in standard ARRL form is transmitted and received during a net session, at the direction of the net control station. This has nothing to do with the individual station traffic count. In a net count there is no breakdown of originated, received, sent and delivered traffic as there is for individual stations. The count is the number of message handlings accomplished during the net's directed sessions. This is simple enough, yet there seems to be considerable confusion about it. A few examples may be helpful:

1. Upon conclusion of his directed net, an NCS operator finds that there were 23 messages reported into the net and that 20 of these were "cleared"—that is, at his direction the messages were transmitted by the station holding them and accepted for by the station receiving them. The total traffic count for this net session was therefore 20. It makes no difference to the total count whether the messages were originals with the transmitting station, whether he is relaying them, whether they are addressed to the receiving station, delivered by the latter or relayed by him. All the net is concerned with is handling them, from one station to the other. Note that the net does not get credit for traffic reported, only for traffic cleared.

2. The net control must base his count on the figures reported to him by net stations. Thus, if a station reporting into the net says he has five messages and later succeeds in clearing them at net control's direction, the net gets credit for handling five messages. However, if the net control dispatches this station and the station to receive the messages to a side frequency to clear them, then closes the net five minutes later, the NCS won't know whether the traffic was successfully cleared, or how many were cleared. If he checks with the operators later, he can enter the exact count. Otherwise, knowing the ability of the two operators concerned, he can estimate what proportion of the traffic was cleared. It is not considered ethical to QNY large amounts of traffic just prior to closing a net and then count all such traffic as having been cleared during QND.

3. Booked messages may be reported into the net as book traffic while indicating the necessary routing information to the net control station. The practice of counting book traffic as "3 for 1" has been discontinued for both net and individual traffic counts.

Don't waste valuable net time fussing about the count. The important thing is to get the traffic handled!

### 10.2 Individual Traffic Count

As already mentioned, the individual's traffic count does not have any correlation to the net's traffic count; it is a separate count that each traffic handler should report to his/her STM or SM each month. Traffic totals may be included in the SM's monthly report to ARRL HQ; this information is then published in "Section News" in *QST*. Here are the definitions of each message category:

**Originated**—One point for each message from a third party for sending via your station. This "extra" credit is given for an off-the-air function because of the value of contact with the general public.

**Sent**—Every message sent over the air from your station to another amateur receives a point in this category. Thus, a message that is eligible for an Originated point as above receives another point when it is sent on the air. Likewise, a message that is received on the air conveys a Sent point when it is relayed to another station. A message that you initiate yourself, while it gets no Originated point, gets a Sent point when cleared. All Sent points require on-the-air sending.

**Received**—A message received over the air gets a Received point, whether received for relaying (sending) or for delivery to the addressee. Any message received which is not eligible for a Delivery point (such as one addressed to yourself) is nevertheless eligible for a Received point.

**Delivered**—The act of delivery of a message to a third party receives a point in this category, in addition to a Received point. This is strictly an off-the-air function and must be coupled with receipt of the message at your station. Thus you can't get a Delivered point unless you first get a Received point.

# NTS Chapter Eleven

## On Getting More Traffic

A concern has been expressed that the addition of digital stations will “rob” traditional NTS nets of their lifeblood, traffic. A look at the current net statistics in *QST* will show that many region nets are handling only a few messages per session. There is no question that without traffic, NTS nets will starve and die. Each and every one of us, therefore, must do our part to support the origination of more traffic:

1. Each Section or Local NTS net in the section should sponsor a message fair at a public place or event once or more a year. Nets should coordinate their scheduling of events throughout the year. This may be a good project for even a Region net, that could sponsor a message booth at a large, regional exposition, for example. Not only would this program of public contact generate more traffic, but it would also provide a great social event for net members themselves, resulting in closer bonding and higher morale.

2. Each Official Relay Station appointee should be encouraged to originate a minimum of 10 messages per month.

3. Each traffic handler in the section should be encouraged to bring at least one message per net check-in. Checking in QRU is to be frowned upon, akin to going to a pot-luck supper without your contribution of a dish! *“Each one, bring one,”* should be every net’s motto.

4. Section Traffic Managers should install Local NTS nets on repeaters to gain access to new Technicians. New traffic handlers mean more traffic. A side-benefit is that there will be new candidates for upper level liaison and NCS functions following service of their apprenticeships at the Section level and below. Far too many region nets, for example, rely on one or two net members to carry the workload over the majority of sessions per week.

5. PBBS software should be incorporated on NTS-cooperative boards to prompt/teach users on how to originate/send a message in radiogram format. A separate, stand-alone program should also be developed for use “off-line” to accomplish the same function.

6. Basic educational/motivational articles should appear more regularly in *QST* and other League publications. Send your contributions to HQ for use in *QST*.

7. The traffic handling community is encouraged to take advantage of the NTS awards program (PSHR, BPL, etc) sponsored by ARRL.

8. NTS Officials are to be encouraged to put on traffic handling seminars for new hams at conventions, hamfests and club meetings to generate interest in our activity. When was the last time you saw a traffic handling forum on a convention program? Fifteen years ago, they were a regular fixture at every convention. Now, it’s the rare event where you’ll see one. Let’s change this sorry situation!



# APPENDIX

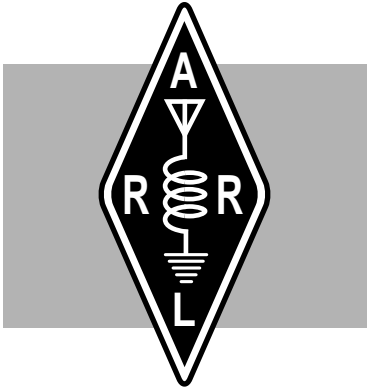

# National Traffic System Terms of Reference

## Article One: Name

The name of the organization shall be the \_\_\_\_\_ **Area Staff**. The \_\_\_\_\_ Area encompasses the \_\_\_\_\_ Regions of the National Traffic System.

## Article Two: Purpose and General Functions

The purpose of the \_\_\_\_\_ Area Staff is to implement the mission of the National Traffic System above the section level in the \_\_\_\_\_ Area as prescribed in the *Public Service Communications Manual*. The National Traffic System provides an integrated network structure to promote accurate and efficient movement of message traffic from origin to destination as a public service, and to train a cadre of Amateur Radio operators to handle message traffic in an organized, coordinated network environment.

The functions of the \_\_\_\_\_ Area Staff are as follows:

1) Management of the daily operation of the Digital Station, Transcontinental Corps (TCC), Area Net, and Region Net functions in the \_\_\_\_\_ Area in accordance with the policies and procedures prescribed in the *Public Service Communications Manual*. Temporary deviations from the standards are coordinated with and approved by the Area Staff Chairman, in cooperation with other affected Areas.

2) Responsibility for administration of the National Traffic System at the Section level is vested in the office of the Section Manager, and under delegated authority, the Section Traffic Manager. The Area Staff shall cooperate with Section level officials to foster a harmonious relationship between the Section and higher levels of the System.

3) Study and make recommendations on System development issues. To meet this responsibility, the Staff may retain the services of expert advisors as Associate Members on an ad hoc basis. See Article Four: Membership. Recommendations for specific actions shall be delivered to the Chairman for joint review and action by the three Area Staff Chairmen and the Field Services Manager, as appropriate.

## Article Three: Specific Responsibilities

Other specific responsibilities of the Staff members are as follows:

### **TCC Directors:**

1) Manage TCC scheduled functions. Appoint capable, experienced operators to the schedules assigned to related NTS cycles.

2) Maintain close association with the assigned TCC operators and with all other TCC Directors in the System. Represent the collective views of the operators to the Area Staff on questions involving NTS policies and procedures.

3) Provide leadership and work with other NTS Officials to establish additional schedules, links, hot lines, or gateways between Regions and Areas of the System when needed.

### **Digital Coordinators:**

1) Establish digital communication standards for NTS applications in consultation with Digital Station operators.

2) Expand NTS capabilities, especially in the areas of system redundancy/reliability and emergency/disaster communications.

- 3) Integrate digital communications with other modes within the system.
- 4) Appoint and manage the Digital Station roster within the area.

#### **Area Net Managers:**

- 1) Manage net operation in general. Work with Region Net Managers for the provision of representatives from the Region nets.
- 2) Maintain close association with net appointees, and represent their collective views to the Area Staff on questions involving NTS policies and procedures.

#### **Region Net Managers:**

- 1) Manage net operation in general. Appoint and train qualified net control stations. Appoint representatives to the Area Net. Work with Section-level officials for the provision of liaison stations from Section to Region Nets.
- 2) Maintain close association with net appointees, and represent their collective views to the Area Staff on questions involving NTS policies and procedures.

#### **All NTS Officials:**

- 1) Nominate candidates for the position of TCC Director, Digital Coordinator, Region and Area Net Manager, when vacancies occur. Ensure that all candidates are current League members. Elect replacements by popular vote.
- 2) Resolve net, TCC function and digital station problems in cooperation with the Area Staff Chairman and Field Services Manager (FSM), as appropriate.
- 3) No action or recommendation of an Area Staff will usurp the broad prerogatives of individual TCC Directors, Digital Coordinators, Region and Area Net Managers in matters concerning the internal operation of the net, or function, except in those subject to review by the full Area Staff due to possible impact on the System external to the net.
- 4) Issue certificates to net or function operators as required.
- 5) Report monthly on net/function activity to ARRL Headquarters.

#### **Article Four: Membership**

The \_\_\_\_\_ Area Staff shall consist of the following Full Members with voting privileges:

- 1) **TCC Directors.** Elected by plurality vote of the Staff. Term of appointment shall be indefinite subject to the maintenance of satisfactory performance.
- 2) **Area Net Managers.** Elected by plurality vote of the Staff. Term of appointment shall be indefinite subject to the maintenance of satisfactory performance.
- 3) **Region Net Managers.** Elected by plurality vote of the Staff. Term of appointment shall be indefinite subject to the maintenance of satisfactory performance.
- 4) **Digital Coordinators.** Elected by plurality vote of the Staff. Term of appointment shall be indefinite subject to the maintenance of satisfactory performance.
- 5) **Members-at-Large.** (Optional). Elected by plurality vote of the Staff. Term of appointment shall be two calendar years. There shall be two MAL positions.
- 6) The Area Staff Chairman may appoint additional advisors as Associate Members on an ad hoc basis during studies of specific development issues. Associates do not hold Area Staff voting privileges, and are not entitled to NTS funding.

## Article Five: Area Staff Chairman

The Chairman shall be elected from the Staff membership by plurality vote of the Staff to serve a term of two years.

The responsibilities of the Chairman are as follows:

1) The Chairman shall hold full responsibility and authority for the management, control and direction of \_\_\_\_\_ Area Staff functions, in accordance with the policies and procedures specified in the *Public Service Communications Manual*.

2) The Chairman shall represent the \_\_\_\_\_ Area Staff during deliberations of the three Area Staff Chairmen. When a matter involves a major published policy or procedure, or affects the operations of the other NTS Areas, the matter shall be addressed jointly by the three Area Staff Chairmen with recommendations to the Field Services Manager for appropriate action.

3) The Chairman shall conduct Staff elections and notify the Field Services Manager of new appointments to the Staff.

4) The Chairman shall plan and conduct periodic staff meetings. Rules of conduct of meetings are specified by the Chairman.

5) The Chairman shall prepare and submit periodic reports concerning the activities and procedures of his staff.

## Article Six: Methods and Procedures

1) A majority of the Staff will serve as a quorum for official Staff actions. In order for election results to be valid, a majority of the Staff must return completed ballots.

### **Meetings**

2) The Staff may meet periodically, informally or formally, or on-the-air, to address Area Staff matters, problems, and formulate policy recommendations to be submitted to the Area Staff Chairmen. Provided there are sufficient matters requiring in-person consideration, and a specific agenda is established, the Area Staff Chairman may call an in-person meeting. (Travel and accommodation expenses may be borne by the League provided a sufficient appropriation is allocated by the Board of Directors. Such authorizations are addressed by the Area Staff Chairman, and approved by the Field Services Manager.)

3) The Area Staff Chairman shall attend the in-person meetings of the three Area Staff Chairmen when called by the Field Services Manager or by unanimous call of the three Chairmen.

### **General Procedures**

4) The operations of the National Traffic System shall be conducted in accordance with the policies and procedures published in the *Public Service Communications Manual*.

5) Changes to the *Public Service Communications Manual* shall be recommended in writing to the three Area Staff Chairmen with subsequent recommendations forwarded to the Field Services Manager for action.

### **Staff Vacancies**

6) In the event a staff position is to become vacant, the Chairman shall solicit nominations for the replacement. A nomination should be solicited from the outgoing NTS Official. The Chairman shall state a reasonable closing date for nominations. Following the closing date, if more than one valid nomination has been received, an election shall be conducted by the Chairman. If only one

valid nomination is received by the closing date, the Chairman will conduct a survey of the staff for approval of the candidate before notifying the Field Services Manager of the selection. Upon notification, the Field Services Manager will issue the appointment documentation.

7) Staff members not fulfilling basic performance standards will be subject to sanctions including possible appointment revocation by vote of the full staff.

Staff members failing to report assigned net activity for a period of two months without a valid reason, as observed by the Field Services Manager and reported to the Area Staff Chairman, will be subject to appointment termination.

8) Area, Region and Section Net Managers, Digital Coordinators and TCC Directors shall conform their nets and operations to the standards and procedures specified in the *Public Service Communications Manual*, unless otherwise expressly recommended, authorized or directed by the Area Staff Chairman following consultation with Area Staff members, other Area Staff Chairs and/or the Field Services Manager, as required. A Net Manager at any level or NTS Official may be removed from the position for failure to comply with the provisions of this paragraph.

#### ***Travel and Administrative Expenses***

9) All NTS Officials travel is subject to the advance approval of the Field Services Manager. Authorized travel may include: attendance at Area Staff meetings, Region Net Manager-called meetings of Section and NTS Officials residing in the region, and Division Director-called meetings.

10) Reimbursement for administrative expenses of NTS Officials is provided for under the NTS account, authorized annually by the ARRL Board of Directors, and managed and administered by the Field Services Manager. Reimbursable items include: postage, telephone, office supplies, and printing. In no case will an NTS Official be reimbursed more than ten dollars of telephone expenses per 30-day period of activity. ARRL Section and NTS Official spending guidelines are available from the Field Services Manager.

#### ***Amendment of Terms of Reference***

11) These articles may be amended by a three-fourths vote of all \_\_\_\_\_ Area Staff voting members. Amendments are subject to the approval of the Field Services Manager.